

# Code of Practice (Part -1)

## Cross Section



## IUT

This document has been prepared by the Transportation Research and Injury Prevention Programme (TRIPP) for the Institute of Urban Transport (IUT), Ministry of Urban Development. The primary purpose of this document is to provide a code of practice for various Urban Road Components. It has been developed in five parts. This is part one of five, which elaborates various norms and standards for cross section design.

## TABLE OF CONTENTS

<b>TABLE OF CONTENTS</b> .....	<b>2</b>
<b>TABLE OF FIGURES</b> .....	<b>3</b>
<b>LIST OF TABLES</b> .....	<b>4</b>
<b>1. INTRODUCTION</b> .....	<b>5</b>
<b>2. SCOPE</b> .....	<b>5</b>
2.1. NEED OF THE REVISED STANDARDS .....	5
<b>3. ROAD CATEGORIES</b> .....	<b>7</b>
<b>4. ELEMENTS OF DESIGN</b> .....	<b>9</b>
4.1. FACTORS COVERING DESIGN .....	9
4.2. SIGHT DISTANCE .....	10
4.3. DESIGN OF VERTICAL ALIGNMENT .....	13
4.4. DESIGN OF HORIZONTAL ALIGNMENT .....	14
4.5. DESIGN SPEED: .....	14
4.6. UTILITIES .....	14
4.7. TRAFFIC CONTROL DEVICES .....	18
<b>5. DESIGN COMPONENTS- CROSS SECTIONS</b> .....	<b>19</b>
5.1. CARRIAGEWAY .....	19
5.2. INFRASTRUCTURE FOR NON MOTORIZED VEHICLES .....	20
5.3. PEDESTRIAN PATHS .....	21
5.4. MEDIANS .....	25
5.5. SEGREGATORS / CURBS .....	25
5.6. SERVICE LANES .....	26
5.7. PARKING .....	26
5.8. TREE BELTS / GREEN BELTS/ LANDSCAPED .....	26
5.9. BUS SHELTERS .....	27
5.10. OTHER FEATURES – STREET FURNITURE & SUPPORT FACILITIES .....	27
5.13. CROSS SECTIONS .....	30
5.14. READY RECKONERS .....	49
<b>6. GRADE SEPARATED FACILITIES</b> .....	<b>53</b>
6.1. PEDESTRIAN SUBWAY .....	53
6.4. PEDESTRIAN OVER HEAD BRIDGES .....	55
6.5. KEY FEATURES TO MAKE GRADE SEPARATED ALTERNATIVES INCLUSIVE: .....	56
<b>7. BACKGROUND NOTES</b> .....	<b>61</b>
7.1. ANNEXURE 1 .....	61
7.2. ANNEXURE 2 .....	70
7.3. ANNEXURE 3 .....	74

## TABLE OF FIGURES

FIGURE 3-1 SCHEMATIC SKETCH OF TRAFFIC IN INDIA ON THE FOUR CATEGORIES OF ROADS .....	8
FIGURE 4-1 TYPICAL SECTION WITH SERVICES .....	15
FIGURE 5-1 FIGURE SHOWING THE CATEGORY OF ROAD USERS .....	19
FIGURE 5-2 FIGURE SHOWING DIFFERENT DESIGN COMPONENTS OF THE ROAD, TO BE DESIGNED FOR THE DIFFERENT ROAD USERS .....	19
FIGURE 5-3 SPACE ALLOCATION FOR ARTERIAL AND SUB ARTERIAL ROADS (STANDARD REQUIREMENTS) .....	23
FIGURE 5-4 SPACE ALLOCATION FOR ARTERIAL AND SUB ARTERIAL ROADS (STANDARD REQUIREMENTS) .....	24
FIGURE 5-6 GAP IN MEDIAN AT PEDESTRIAN CROSSINGS .....	25
FIGURE 5-7 CROSS SECTION ARTERIAL ROAD.....	31
FIGURE 5-8 PLAN AND SECTION –DISTRIBUTORY ROAD.....	32
FIGURE 5-9 CROSS SECTION –ACCESS ROAD (ROW 12 -30M, DESIGN SPEED 3KMPH) .....	33
FIGURE 5-10 CROSS SECTIONS FOR DIFFERENT ROWs (38.60 M TO 57.00M).....	34
FIGURE 5-11 CROSS SECTIONS FOR DIFFERENT ROWs (42.60M TO 60.20M) .....	35
FIGURE 5-12 CROSS SECTIONS FOR DIFFERENT ROWs (55.70M TO 71.80M) .....	36
FIGURE 5-13 CROSS SECTIONS FOR DIFFERENT ROWs (48.30M TO 62.50M) .....	37
FIGURE 5-14 CROSS SECTIONS FOR DIFFERENT ROWs (45.00M TO 61.30M) .....	38
FIGURE 5-15 CROSS SECTIONS FOR DIFFERENT ROWs (38.60M TO 52.20M) .....	39
FIGURE 5-16 CROSS SECTIONS FOR DIFFERENT ROWs (47.60M TO 71.70M) .....	40
FIGURE 5-17 CROSS SECTIONS FOR DIFFERENT ROWs (42.40M TO 66.50M) .....	41
FIGURE 5-18 CROSS SECTIONS FOR DIFFERENT ROWs (38.40M TO 57.50M).....	42
FIGURE 5-19 CROSS SECTIONS FOR DIFFERENT ROWs (43.50M TO 62.70M).....	43
FIGURE 5-20 CROSS SECTIONS FOR DIFFERENT ROWs (41.50M TO 49.49M) .....	44
FIGURE 5-21 CROSS SECTIONS FOR DIFFERENT ROWs (24.00M TO 39.00M).....	45
FIGURE 5-22 CROSS SECTIONS FOR DIFFERENT ROWs (49.00M TO 62.40M).....	46
FIGURE 5-23 CROSS SECTIONS FOR DIFFERENT ROWs (42.60 M TO 60.20M).....	47
FIGURE 5-24 CROSS SECTION –ROW 45M .....	48
FIGURE 5-25 CROSS SECTION –ROW 75M .....	48
FIGURE 6-1 INTRODUCTION OF SUBWAY - PLAN.....	53
FIGURE 6-2 HALF SUBWAY – SECTION .....	54
FIGURE 6-3 FULL SUBWAY – SECTION .....	54
FIGURE 6-4 ACCESS TO THE SHELTER – OVERHEAD PEDESTRIAN BRIDGE WITH STEPS.....	55
FIGURE 6-5 ACCESS TO THE SHELTER – OVERHEAD PEDESTRIAN BRIDGE WITH STEPS AND ESCALATOR .....	56
FIGURE 6-6 ACCESS TO THE SHELTER – OVERHEAD BRIDGE WITH STEPS AND ESCALATOR AND LIFTS .....	56
FIGURE 7-1 PERSON USING WHEELCHAIR (ELEVATION) .....	61
FIGURE 7-2 VEHICLE DIMENSIONS FOR PASSENGER RICKSHAW .....	62
FIGURE 7-3 VEHICLE DIMENSION FOR ADULT TOURING BIKE WITH GOODS .....	62
FIGURE 7-4 VEHICLE DIMENSIONS FOR GOODS RICKSHAW .....	63
FIGURE 7-5 VEHICLE DIMENSIONS OF ADULT TOURING BIKE .....	63
FIGURE 7-6 DIRECTION OF PATH COVERED BY A PASSENGER CAR.....	66
FIGURE 7-7 DIRECTION OF PATH COVERED BY A FIRE TENDER.....	67
FIGURE 7-8 DIRECTION OF PATH COVERED BY GOODS VEHICLE.....	68
FIGURE 7-9 IDENTIFICATION OF ACTIVITIES ON A SURVEY PLAN AT SITE .....	72
FIGURE 7-10 LAND USE PLAN - TRANSFER TO DRAWING .....	73
FIGURE 7-11 SPEED AND SIDE FRICTION FACTOR GRAPH .....	76

## LIST OF TABLES

TABLE 3-1 ROAD TYPOLOGY.....	8
TABLE 4-1 FRICTION FACTOR VALUES.....	10
TABLE 4-2 STOPPING SIGHT DISTANCE VALUES FOR DIFFERENT SPEEDS.....	11
TABLE 4-3 STOPPING SIGHT DISTANCE ON GRADES.....	11
TABLE 4-4 DECISION SIGHT DISTANCE.....	12
TABLE 4-5 RECOMMENDED DESIGN SPEEDS FOR DIFFERENT CLASSES OF URBAN ROADS.....	14
TABLE 4-6 FRICTION FACTOR FOR DIFFERENT DESIGN SPEEDS FOR DESIGNING DIFFERENT TYPE OF FACILITIES.....	14
TABLE 4-7 REQUIRED ILLUMINATION LEVELS FOR DIFFERENT TYPES OF ROADS.....	16
TABLE 4-8 BROAD RECOMMENDATIONS ABOUT DEPTH OF LAYING (DENOTING THE BOTTOM OF TRENCH) OF SERVICES.....	17
TABLE 5-1 DESIGN SPEED AND CARRIAGEWAY WIDTH RECOMMENDED FOR DIFFERENT ROAD CATEGORIES.....	20
TABLE 5-2 INFRASTRUCTURE FOR NMV.....	20
TABLE 5-3 CUMULATIVE PERCENTAGE OF MOBILITY IMPAIRED PEOPLE OBSERVED TO BE UNABLE TO MOVE MORE THAN THE STATED DISTANCE IN CITY CENTRES WITHOUT REST.....	21
TABLE 5-4 PEDESTRIAN PATHS.....	21
TABLE 5-5 COMPONENTS OF INCLUSIVENESS.....	22
TABLE 5-6 PARKING ON DIFFERENT ROADS.....	26
TABLE 5-7 PERCENTAGE OF PEOPLE ABLE/ WITH ASSISTANCE MOVE AT LEAST THE STATED DISTANCE WITHOUT A REST.....	30
TABLE 5-8 RECOMMENDED WALKING DISTANCE LIMIT WITHOUT A REST FOR PEOPLE WITH VARIOUS IMPAIRMENTS.....	30
TABLE 5-9 CROSS SECTION TYPES OF VARYING ROWS.....	30
TABLE 5-10 READY RECKONER FOR RESIDENTIAL ZONE.....	49
TABLE 5-11 READY RECKONER FOR COMMERCIAL ZONE UP TO 30M ROW.....	50
TABLE 5-12 READY RECKONER FOR COMMERCIAL ZONE ABOVE 30M ROW.....	50
TABLE 6-1 ADVANTAGES ASSOCIATED WITH GRADE NMV OVERPASS OR AN UNDERPASS.....	57
TABLE 7-1 NMV VEHICLE DIMENSIONS.....	62
TABLE 7-2 CHARACTERISTICS –CYCLES.....	64
TABLE 7-3 CHARACTERISTICS –2 WHEELERS.....	64
TABLE 7-4 CHARACTERISTICS –3 WHEELERS.....	65
TABLE 7-5 CHARACTERISTICS –CARS.....	65
TABLE 7-6 CHARACTERISTICS –BUSES.....	69
TABLE 7-7 CHARACTERISTICS –HIGH CAPACITY BUS.....	69

## 1. INTRODUCTION

Urban roads in India have a heterogeneous mix of traffic. These include the pedestrians, slow moving vehicles like bicycles, rickshaws both for passenger and freight movement and fast motorized vehicles like motorcycles, scooters, three wheelers, cars and public transport vehicles. The space occupied by each of these vehicles, accelerations and deceleration characteristics and possible maximum speeds by each user is variable. Therefore space allocation to different vehicles has to be carefully ensured to achieve a smooth and safe flow of traffic.

The type and character of each urban road needs to be carefully detailed to respond to the functions it performs, i.e. providing mobility or access or both. Safety of road users is a major concern now because the number of traffic accidents and fatalities on urban roads has continued to increase in the past few years. Therefore application of appropriate geometric design standards on urban roads is essential to ensure the safety to all road users. A design of the entire road cross-section holds considerable importance, as

- It governs the design speed of vehicles
- Reflects prioritization in space allocation
- Introduces concepts of universal design and traffic calming.

## 2. SCOPE

These sets of codes to design urban roads is an attempt to make a bridge between the current research on safe urban roads and road design in our cities today. The Indian Roads Congress Standard (IRC) code for urban roads, IRC 86-1983, *The Geometric Guidelines for Urban Roads in Plains*, focuses on the safe and economic operation of the vehicle. The design speed limits and design standards have to be brought into conformity with the requirements of sustainable safety principles accepted universally. Also, our cities, and urban roads today have to be adapted to the concept of the universal design in all its totality. The roads today need to be “barrier free” and accessible by “all” including people with disabilities. This discussion on inclusive mobility is reflected in the proposed design standards with special attention to the details required in infrastructure and its various design components.

### 2.1. NEED OF THE REVISED STANDARDS

These guidelines give focus to the requirements of pedestrians, non motorized users and the public transport users in urban areas. These three groups form the basis of sustainable transport systems. The current National Urban Transport Policy adopted by the central government in 2006 also lays emphasis on designing the cities for people and not for vehicles( MoUD, 2006). Therefore the road standards have been modified to reflect the priority of sustainable transport modes over ensuring mobility of personal motorized vehicles only.

Pedestrians, bicyclists and non-motorized rickshaws are the most critical elements in mixed traffic. If the infrastructure design does not meet the requirements of these elements, all modes of transport operate in sub-optimal conditions. At present, pedestrians, bicyclists and other non motorized vehicles users are the captive users of these modes. Despite unsafe conditions present on the road they continue to use these modes because their socio economic condition does not permit them to use motorized vehicles. These users have opted for walking, cycles or public transport because it is needed for their very survival. They are willing to defy the formal street design, which is hostile to them. If our future cities have to meet the demands of sustainability, then we have to ensure that these environment friendly modes are used as a preferred choice over short motorized trips. A reversal of current trend is possible. It is possible to design pedestrian, bicycle and public transport friendly

urban roads. The guiding principle for such a design is meeting the needs of pedestrians, bicyclists and public transport commuters in that order.<sup>1</sup>

Use of alternative transportation systems, active transport, bus priority systems, open and green landscapes, pedestrian only areas are being seen as an opportunity to revive the city. The roads today therefore need to address these issues by giving priority in thought and design of our urban roads.

In view of the current modal shares and growth rates of cars, two wheelers and para transit vehicles, it is recognized that two wheelers (motorcycles, and scooters) will continue to play a dominant role in the medium and small cities. The para transit vehicles like three wheelers, tempos and rickshaws will continue to play an important role either as feeder system to the formal public transport systems or as semi public transport systems in small and medium size cities. These Guidelines are revised to cater to their needs as well.

In preparation of these guidelines, the provision of various IRC codes have been considered and taken into account( Annexure 1).

---

<sup>1</sup> [http://www.fadaweb.com/urban\\_transport.htm](http://www.fadaweb.com/urban_transport.htm) as accessed on 06/11/2009

### 3. ROAD CATEGORIES

An efficient urban road network, follows a hierarchy. The hierarchy is based on the function that the road is expected to perform, and the type of traffic and the road users present on the road. The design speeds, road widths and other geometric features are adapted to suit the road function. These guidelines are based on the following classification of urban road:

#### 1. Arterial Roads

They are the primary roads for ensuring mobility function. They carry the largest volumes of traffic and longest trips in a city. These roads are characterized by mobility and cater to through traffic with restricted access from carriageway to the side. In such cases, special provisions should be introduced to reduce conflict with the through traffic. These roads have the maximum right of way amongst the four categories and cater to a speed limit of 50-60 km/h and a ROW of 50-80 m.

#### 2. Sub Arterial Roads

This category of road follows all the functions of an Arterial Urban road and are characterized by mobility, and cater to through traffic with restricted access from carriageway to the side. It carries same traffic volumes as the arterial roads. Due to its overlapping nature, Sub arterial roads can act as arterials. This is context specific and is based on the function and the land use development it passes through and caters to a speed limit of 50 km/h (same as arterial roads). The ROW of this category of roads varies from 30-50 m.

#### 3. Distributor/Collector Roads

As the name suggests, these are connector roads which distribute the traffic from access streets to arterial and sub arterial roads. They are characterized by mobility and access equally. They are characterized by a design speed of 30km/h and have a ROW midway of access streets and two types of arterials i.e. 12-30m. It carries moderate traffic volumes compared to the arterial roads. Due to its overlapping nature, distributor roads can act as a sub arterial and as access streets, depending upon the function and the land use of the surroundings.

#### 4. Access Streets

These are used for access functions to adjoining properties and areas. A majority of trips in urban areas usually originate or terminate on these streets.<sup>2</sup> They cater to a design speed of 15-30km/h and have a road right of way of 15m-30m. They carry relatively lower volumes of traffic at low speeds. They are characterized by access predominantly; they can be used for collector functions.

Based on the function the classification of the roads is decided and an appropriate design speed is adapted. The design speed governs the geometric design of the right of way and the cross section elements of the road.

<sup>2</sup> IRC : 86 – 1983, Geometric Design Standards for Urban Roads in Plains, Indian Road Congress, 1983

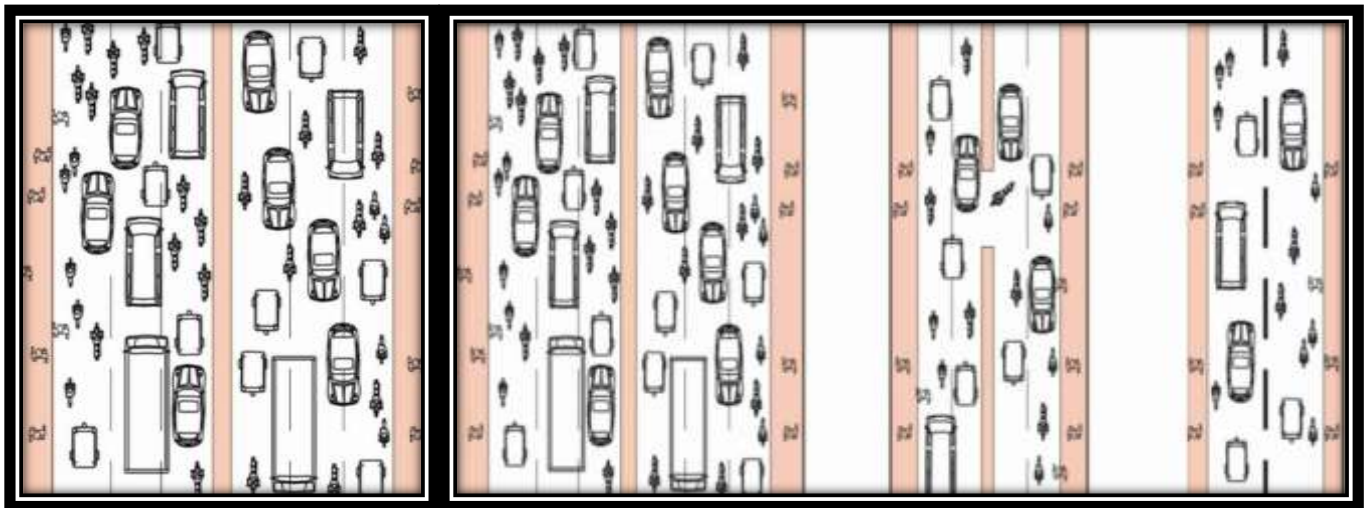

Arterial (ROW-50m to 80m)  
50km/h

Sub Arterial (ROW-30m to 50m)  
50km/h

Distributor  
(ROW-12m to 30m)  
30km/h

Access  
(ROW-6m to 15m)  
15km/h

Figure 3-1 Schematic Sketch of traffic in India on the four categories of roads

According to IRC: 86 – 1983, (Geometric Design Standards for Urban Roads in Plains, Indian Road Congress, 1983) the urban roads other than express ways are classified in four main categories.<sup>3</sup>

Table 3-1 Road Typology<sup>4</sup>

Road Typology	Right of Way-ROW (m)	Design speed (km/hr)
Arterial Roads	50-80	50
Sub Arterial Roads	30-50	50
Distributor/Collector Roads	12 - 30	30
Access Streets	6 - 15	15

<sup>3</sup> IRC : 86 – 1983, Geometric Design Standards for Urban Roads in Plains, Indian Road Congress, 1983

<sup>4</sup> Typology of Road, Chapter 4, IRC:86-1983, Geometric Design Standards for Urban Roads in Plains,.



## 4. ELEMENTS OF DESIGN

The alignment of any road comprises of various elements that together will create a safe and smooth facility for the intended function. These include the factors listed below:

### 4.1. FACTORS COVERING DESIGN<sup>5</sup>

#### 4.1.1. HUMAN FACTORS<sup>6</sup>

1. Driver Behaviour – Cars and two wheelers
2. Ability to make decisions and reaction time
3. Driver expectancy
4. Conformance to natural path of movement
5. Pedestrian Behaviour
6. Behaviour of cyclists

#### 4.1.2. TRAFFIC CONSIDERATION<sup>11</sup>

1. Design and actual capacities
2. Design hour turning movements
3. Size and operating characteristics of vehicles.
4. Types of movement
5. Vehicle Speeds
6. Transit involvement
7. Accident experience
8. Traffic mix, i.e. proportion of heavy and light vehicle and including pedestrians and NMV users.

#### 4.1.3. ROAD AND ENVIRONMENTAL CONSIDERATIONS<sup>11</sup>

1. Character and use of abutting property
2. Vertical and horizontal alignment at the intersection

<sup>5</sup> 4.1.1 – 4.4 , AASHTO – Geometric Design of Highway and Streets

<sup>6</sup> Guidelines For the Design of At-Grade Intersections in Rural and Urban Areas , September 1994, The Indian Roads Congress

3. Sight distance
4. Angle of intersection
5. Conflict area
6. Geometric features
7. Traffic control devices
8. Lighting equipments
9. Environmental features( Trees, landscaping)
10. Presence of street vendors

#### 4.1.4. FUNCTIONAL INTERSECTION AREA

1. Perception-reaction distance
2. Maneuver distance
3. Queue storage distance

#### 4.2. SIGHT DISTANCE

The coefficient of friction  $f$  depends on several factors such as type and condition of pavement surface and tyres. Also the value of  $f$  decreases with increase in speed IRC recommends the following  $f$ -values for design.

Table 4-1 Friction factor values

Speed, Km/h	20 to 30	40	50	60	65	80	100
Longitudinal coefficient of friction, $f$	0.4	0.38	0.37	0.36	0.36	0.35	0.35

$$d^7 = 0.278 V t + 0.039 V^2/a$$

$d$  = breaking distance, m;

$t$  = brake reaction time, 2.5 s;

$V$  = design speed, km/h;

$a$  = deceleration rate,  $m/s^2$

<sup>7</sup> American Association of State Highway and Transportation Officials (1994) - Geometric Design of Highways and Streets page no. 113

Table 4-2 stopping sight distance values for different speeds

Design speed (km/h)	lag distance (m)	Braking distance (m)	stopping sight distance	
			Calculated (m)	Design (m)
20	13.9	3.9	17.8	20
30	20.8	8.8	29.7	30
40	27.8	16.6	44.3	45
50	34.7	26.6	61.3	65
60	41.7	39.3	81.0	85

Source: American Association of State Highway and Transportation Officials (1994) - Geometric Design of Highways and Streets page no. 112

### Effect of Grade on Stopping:

When there is an ascending gradient of say, +n% the component of gravity adds to the braking action and hence braking distance is decreased.

$$d^8 = V^2 / 254 ( (a/9.81) \pm G )$$

**d** = braking distance, m;

**V** = design speed, km/h;

**a** = deceleration rate, m/s<sup>2</sup>;

**G** = percent of grade divided by 100

Table 4-3 Stopping sight distance on grades

Design speed (km/h)	Stopping sight distance (m)					
	Upgrades			Downgrades		
	3%	6%	9%	3%	6%	9%
20	18	17	17	18	19	19
30	29	29	28	30	31	32
40	43	42	41	46	47	49
50	59	58	56	64	66	70
60	78	75	73	85	89	94

Source: American Association of State Highway and Transportation Officials (1994) - Geometric Design of Highways and Streets page no. 115

<sup>8</sup> American Association of State Highway and Transportation Officials (1994) - Geometric Design of Highways and Streets page no. 114

**Decision Sight Distance:**

Intersection sight distance is the decision needed to safely proceed through an intersection. The distance needed depends on the type of traffic control at the intersection, and the maneuver (left turn, right turn, or proceeding straight). Uncontrolled intersections on highways require the most. Decision sight distance is used when drivers must make decisions more complex than stop or don't stop. It is longer than stopping sight distance to allow for the distance traveled while making a more complex decision. The decision sight distance is "distance required for a driver to detect an unexpected or otherwise difficult-to-perceive information source or hazard in a roadway environment that may be visually cluttered, recognize the hazard or its threat potential, select an appropriate speed and path, and initiate and complete the required maneuver safely and efficiently."<sup>9</sup>

Drivers need decision sight distances whenever there is likelihood of error in information reception, decision-making, or control actions. Examples of critical locations where these kinds of errors are likely to occur, and where it is desirable to provide decision sight distance include interchange and intersection locations where unusual or unexpected maneuvers are required, changes in cross section such as toll plazas and lane drops.

According to AASHTO<sup>10</sup>, the following aspects of sight distance are important while designing alignments:

1. the sight distances needed for stopping;
2. the sight distances needed for the passing of overtaken vehicles;
3. the sight distances needed for decisions at complex locations;

Table 4-4 Decision sight distance

Design speed (km/h)	Decision sight distance (m)	
	B <sup>11</sup>	E <sup>12</sup>
20	55	80
30	85	120
40	120	160
50	155	195
60	195	235

Source: American Association of State Highway and Transportation Officials (1994) - Geometric Design of Highways and Streets page no. 116

<sup>9</sup> American Association of State Highway and Transportation Officials (1994) *A Policy on Geometric Design of Highways and Streets* page no. 117-118

<sup>10</sup> Sight Distances, Chapter 3, American Association of State Highway and Transportation Officials (1994) – Geometric Design of Highways and Streets

<sup>11</sup> Stop on urban road— $t = 9.1$  s

<sup>12</sup> Speed/path/direction change on urban road— $t$  varies between 14.0 and 14.5 sec

The decision sight distances on urban road are determined as:

$$d = 0.278 V t + 0.039 V^2 / a$$

**d** = decision sight distances, m;

**V** = design speed, km/h;

**a** = deceleration rate, m/s<sup>2</sup>;

**t** = pre-maneuver time, s (Stop on urban road—t = 9.1 s)

Source: Sight Distances, Chapter 3, American Association of State Highway and Transportation Officials (1994) – Geometric Design of Highways and Streets

The decision sight distances to change speed/path/direction on urban road are determined as

$$d = 0.278 V t$$

**d** = decision sight distances, m;

**V** = design speed, km/h;

**t** = total pre-maneuver and maneuver time, s (Speed/path/direction change on urban road—t varies between 14.0 and 14.5 sec)

Source: Sight Distances, Chapter 3, American Association of State Highway and Transportation Officials (1994) – Geometric Design of Highways and Streets

### 4.3. DESIGN OF VERTICAL ALIGNMENT

Vertical Alignment in Urban Areas is governed by need to match building line and entrance line levels and levels of intersection and median openings.<sup>13</sup>

Vertical curves are introduced for smooth transition at grade changes. The vertical curves used in road design may be classified into two categories

Summit curves or crest curves with convexity upwards

Valley or sag curves with concavity downwards

**Summit curves:** the problem in designing the summit curve is to provide adequate sight distances. The SSD should be provided at all sections of the road system.

Simple parabolic curve is used as the summit curve due to the following reasons.

<sup>13</sup> IRC : 86 – 1983, Geometric Design Standards for Urban Roads in Plains, Indian Road Congress, 1983

Parabola is very easy for arithmetical manipulations for computing ordinates

Use of simple parabola as summit curve is found to give good riding comfort

#### 4.4. DESIGN OF HORIZONTAL ALIGNMENT

Horizontal alignment consists of circular portion flanked by spiral transitions at both ends. Various design factors to be considered in the horizontal alignment are design speed, radius of circular curves, type and length of transition curve, super elevation, coefficient of side friction and widening of pavement on curves.

#### 4.5. DESIGN SPEED:

The design speed is the main factor governing the design of various design features. The sight distance, radius of horizontal curve, super elevation, extra widening of pavement, length of transition curve and the length of summit and valley curves all depend on design speed.

Table 4-5 Recommended design speeds for different classes of urban roads

Road Typology	Design speed(km/hr)
Arterial Roads	50
Sub Arterial Roads	50
Distributory/Collector Roads	30
Access Streets	15

Table 4-6 Friction factor for different design speeds for designing different type of facilities

Design speed (km/h)	Side friction factor, f	minimum superelevation, e	Total e + f	Calculated minimum radius, R (m)	recommended radius, R(m)
15	0.4	0	0.4	4	5
20	0.35	0	0.35	9	10
30	0.25	0.02	0.27	26	30
40	0.23	0.04	0.27	47	50
50	0.19	0.06	0.25	79	80

#### 4.6. UTILITIES

Road utilities are required to provide the necessary service to the roads and the neighboring areas. Although utilities generally have little effect on the geometric design of the highway or street, full consideration should be given to measures, reflecting sound engineering principles and economic factors needed to preserve and protect the integrity and visual quality of the highway or street, its maintenance efficiency, and the safety of traffic.

Here are some guiding principles which should be taken into account while designing the cross section of an urban road.

Utilities should be considered:

1. Before working on the plan
2. Implication on cross-sectional design
3. Implication on materials and design

It is necessary to accommodate utility services along and across the roads. The laying design of utilities has to be done to ease maintenance and operations but keeping in mind that it will affect the traffic flow and conflict with other services to the minimum. Location should be taken up so that minor or no adjustments are required with road works taken up later.

These include the following:

1. Sewer and drainage
2. Storm Water Drain
3. Water Supply lines
4. Electricity Cables
5. Telecommunication cables
6. Gas pipelines
7. Cross conduit ducts
8. Lighting
9. Drainage

Utility duct may be provided to protect cables and pipes against external influences.

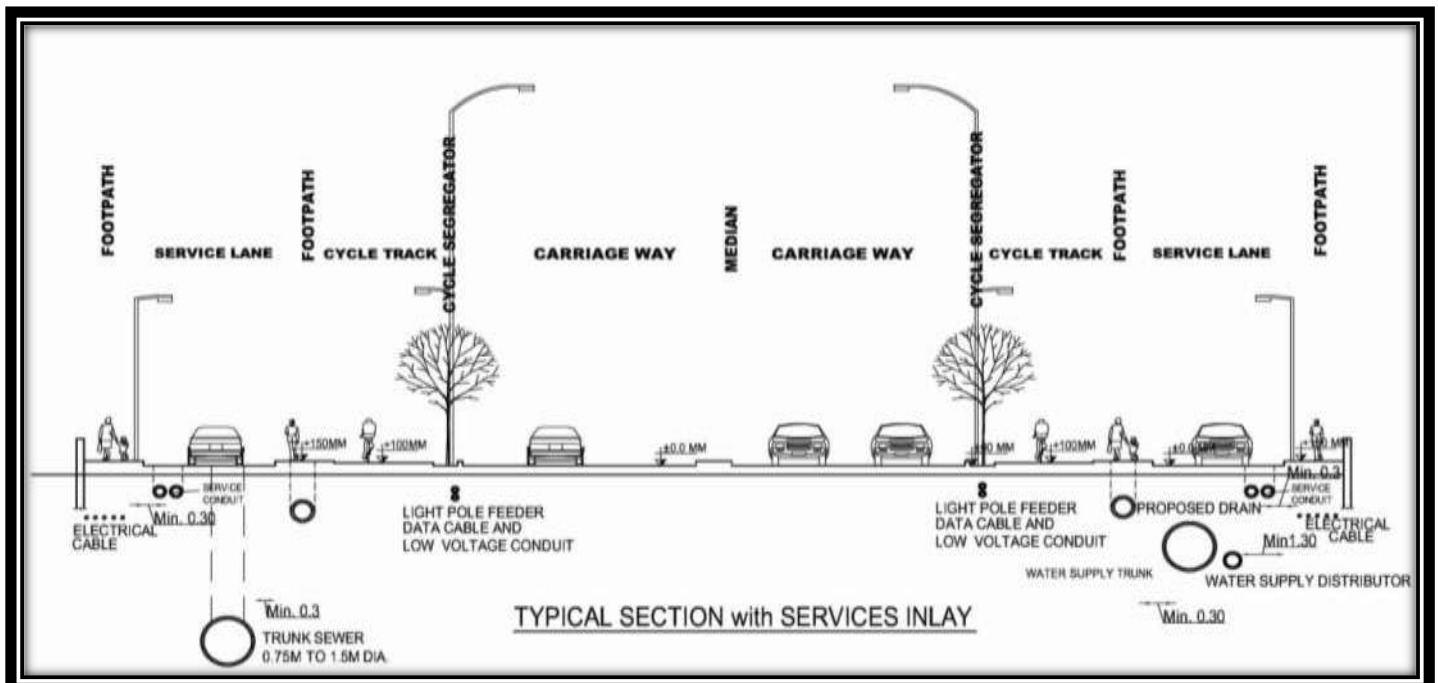

Figure 4-1 Typical Section with Services

## 4.6.1. LIGHTING

Lighting is required for visibility of a roadway and it adds to the safety of all features of a road design.

To minimize the effect of glare and to provide the most economical lighting installation, luminaires are mounted at heights of at least 9 m [30 ft]. Lighting uniformity is improved with higher mounting heights, and in most cases, mounting heights of 10 to 15 m [35 to 50 ft] are usually preferable. High mast lighting, special luminaires on masts of 30 m [100 ft], is used to light large highway areas such as interchanges and rest areas. This lighting furnishes a uniform light distribution over the whole area and may provide alignment guidance. However, it also has a disadvantage in that the visual impact on the surrounding community from scattered light is increased.

Table 4-7 Required illumination levels for different types of roads

Particulars	Illumination Level
Roads	30 lux
Pedestrian crossings	50 lux
Residential street lighting	1 -10 lux
cycle track	20 lux

Facilitation of the above mentioned lighting levels would be done with the use of the luminaire mounted at an appropriate height and horizontal distance. The location of poles is depending on the category of the road. It could be the central verge or the sides where a segregated cycle facility is available. Two luminaires can be mounted on a pole located between the carriageway and the cycle track at different heights to light the required area with the required lux levels. This would also reduce the number of poles required and the vertical clutter on any given road.

The visibility of the course of a cycle track is determined not so much by the amount of light that falls on it but by the amount of light that is reflected by the road surface (luminance).<sup>14</sup> With the view of luminance, the use of concrete is the preferred choice. The disadvantage of using concrete paving is the glare it would produce during the day in harsh Indian summers. Special treatment should be done that would help cyclists to use a segregated cycle facility. These treatments could include plantations providing shade and will also help reduce glare. This is a level of service (LOS) prerequisite for riding comfort.

Street lighting should produce enough intensity required for face recognition and objects from a particular sight distance. Especially for the purpose of social safety, women and children are a special group for whom the color of light is of added importance. White light is a preferred choice. The advantages of white light are as follows:

1. In a segregated facility, it easily distinguishes between the fast and slow moving zone.
2. It easily creates contrast for pedestrians also with tactile paving provided for the differently-abled and the visually impaired.
3. It increases annual savings.

<sup>14</sup> Design Manual for Bicycle Traffic, June 2007, CROW, Page 311.



#### 4.6.2. DRAINAGE

Drainage should be addressed while design of cycle lanes and tracks to prevent ponding and erosions during rains. This would ensure safe usage of bicycle track. Improper design of gully gratings, water collection on the edge of bicycle lanes/tracks will hinder the comfort of riding and will prevent cyclists from its usage.

In arterial roads, by design there should be a segregated bicycling facility or a cycle track. In such cases, there would be a strip/area segregating the carriageway and the bicycle track. This area can be designed where the collection of water takes place i.e. a gully grating can be located from where a pipe can be laid to the main storm drain. The storm water drain can run under the footpath or any area other than below the cycle track because it will hamper the work/movement of cyclists. The water from the carriageway collects into the grating. Also the slope of the cycle track (2%) is towards this area and seeps into the grating by surface drainage. When there is a swale or a green area between the cycle track and the footpath, the surface drainage from the cycle track can be towards this portion using a 2% slope.

In case a segregated facility has provided with the main storm line under the drainage, it should be flush with the floor of the cycle track. The drain can be put along one edge so that in times of an open manhole or annual maintenance work being carried out, one side is available for movement.

For distributor and access streets placing a collection grating along the edge of the footpath could easily do it. A bell mouth arrangement to collect water is not recommended. The grating should be flush with the floor of the carriageway and the cover should not hamper the movement of cyclists. The cover of the grating should be perpendicular to the direction of the travel of bicyclists so that the tyre does not get stuck and make the cyclist fall.

#### 4.6.3. OTHER UTILITIES

There are various utilities running longitudinal and across the ROW of any category road. These include storm drains, underground and overhead electrical lines, gas pipelines, optical fiber cables and others. Usually it is seen that an annual maintenance is required which involves roadwork and therefore disruption of movement of traffic for a temporary period. In such a case, the location and depth of laying these utilities is of utmost importance. Also, for a segregated cycling facility, since the paving is rigid, it is not desired to locate the services/utilities, which require frequent maintenance.

The important point is to rationalize all available existing and proposed services in order of their maintenance works and see if there is any obstacle to the efficiency and functioning of cycling services (as mentioned in the guiding principles).

Apart from the lighting and drainage that is required for a comfortable riding experience, there are other utilities that affect the comfort of cyclists indirectly with the other kind of works involved with the nature of such utilities.

The depth of installation should not be less than 0.6m.<sup>15</sup>

Table 4-8 Broad recommendations about depth of laying (denoting the bottom of trench) of services

S.No	Type of utility	Depth (in meters)
1	Trunk Sewer Line	2 to 6m
2	Water Supply line	1 – 1.5
i	Service Line	0.6 - 1
ii	Trunk Line	1 – 1.5
3	Electric Cable	1 – 1.5

<sup>15</sup> IRC 98-1997, Guidelines on Accommodation of utility services on roads in urban areas.

---

i	LT Cable	0.6 - 1
ii	HT Cable	1.5 - 2
4	Telecommunication cable	2 - 3
i	Directly laid	0.6 - 1
ii	Laid in ducts	2 - 3
5	Gas Mains and lines carrying combustible materials	2 - 3

---

Some of the services mentioned above would require the provision of manholes. Adequate attention should be placed with manhole covers. It should be seen that they do not protrude and are flush with the surface of the component of roadway (discussed later). Periodic Maintenance is required to ensure the safety of road users.

#### 4.7. TRAFFIC CONTROL DEVICES

These include:

1. Traffic signs
2. Road Markings
3. Traffic signals

Traffic signs and Road Markings have been discussed in detail in Code 3 and Code 4 of this manual. Traffic-control signals are devices that control vehicular and pedestrian traffic by assigning the right-of-way to various movements for certain pre-timed or traffic-actuated intervals of time. They are one of the key elements in the function of many urban and some rural streets.

## 5. DESIGN COMPONENTS- CROSS SECTIONS

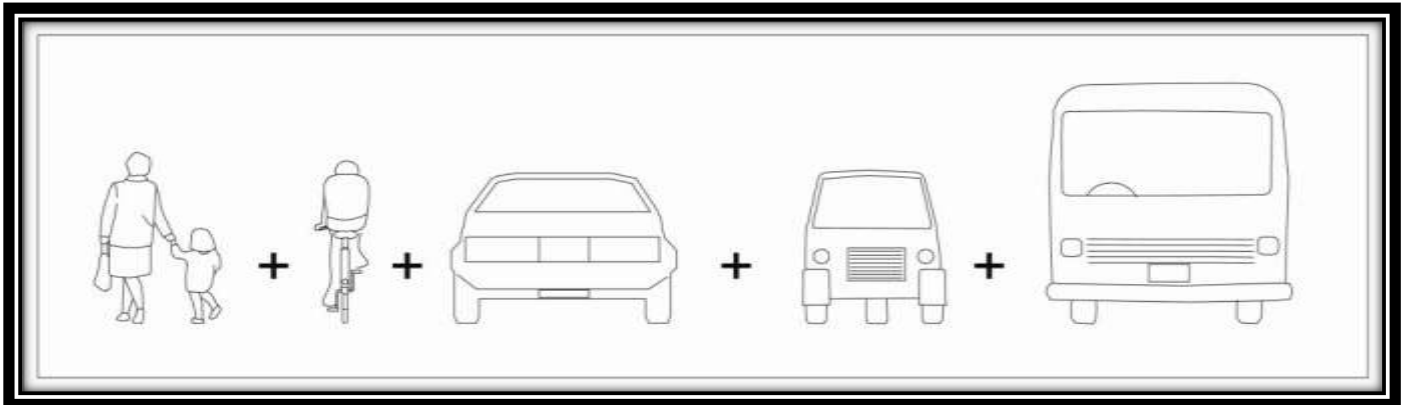

Figure 5-1 Figure showing the category of road users

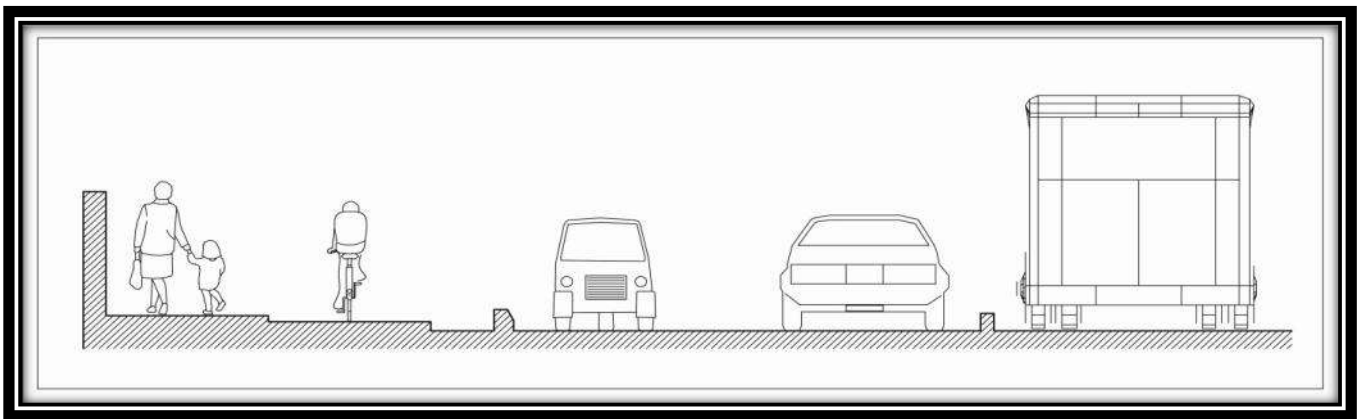

Figure 5-2 Figure showing different design components of the Road, to be designed for the different Road users

The Design components are as follows with the Design Standards

### 5.1. CARRIAGEWAY

This includes the number of lanes required for throughput of motorized traffic.

The motorized vehicles include Public transport vehicles too LANE WIDTHS

The lane widths of a carriageway affect the safety and driving behavior of drivers. Wide lanes encourage higher speeds.

#### Horizontal clearance

For urban arterials, sub arterials, collectors, and local streets where curbs are utilized, space for clear zones is generally restricted. A minimum offset distance of 500 mm [18 in] should be provided beyond the face of the curb, with wider offsets

provided where practical. However, since most curbs do not have a significant capability to redirect vehicles, a minimum clear zone distance commensurate with prevailing traffic volumes and vehicle speeds should be provided where practical.<sup>16</sup>

Table 5-1 Design speed and carriageway width recommended for different road categories

	Arterial Roads	Sub Arterial Roads	Distributory Roads	Access Roads
<b>Carriageway</b>				
<b>Criteria</b>	50 km/h	50 km/h	>30 km/h & < 50 km/h	>15 km/h & >30 km/h
<b>ROW</b>	50m – 80m	30m – 50m	12m – 30m	6m – 15m
<b>Horizontal curve</b>	30m or more	30m or more	10m or more	5m or more
<b>Gradient</b>	2%	2%		
<b>Number of lanes</b>	Minimum 6 lanes divided (using a raised median);	Minimum 4 lanes divided (using a raised median);	Maximum 4 lanes of 3.0m width each (excluding marking) or 2 lanes of 3.0 to 3.3m width each (excluding marking) with or without an intermittent median	1 to 2 lanes, (undivided); of 2.75 to 3.0m width each
<b>Minimum Width for car lane</b>	3.0 to 3.5m width each	3.0 to 3.5m width each	2 lanes of 3.0 to 3.5m width each	2.75 to 3.0m width each
<b>Minimum Width for bus lane</b>	3.5m -(segregated )	3.5m -(segregated ) or painted lane	Mixed traffic	

## 5.2. INFRASTRUCTURE FOR NON MOTORIZED VEHICLES

Cycle infrastructure width requirements are based on vehicle dimensions, volume and clearance requirements of moving vehicles (cycle rickshaw, freight rickshaw). These requirements vary for straight riding cyclists and those maneuvering a bend at a cruising speed.

Exclusive lanes for slow moving vehicles-bicycles and rickshaws and pedestrians along with spaces for street vendors are also essential. Hawkers and roadside vendors provide services to bus commuters and pedestrians therefore designed spaces would discourage them from occupying the carriageway. This improves the capacity of the lanes designed for motorized vehicles and increases safety of bicyclists and pedestrians.

Table 5-2 Infrastructure for NMV

	Arterial Roads	Sub Arterial Roads	Distributory Roads	Access Roads
<b>Non Motorised Vehicle</b>	Segregated Cycle Track	Segregated Cycle Track	Cycle Lane	Mixed \traffic
<b>Location</b>	Between Carriageway or street parking and footpath on either edge of the carriageway	Between Carriageway or street parking and footpath on either edge of the carriageway	On the edge of the carriageway, adjacent to the footpath or parking.	
<b>Gradient</b>	1:12 – 1:20	1:12 – 1:20	1:12 – 1:20	1:12 – 1:20
<b>Lane width</b>	2.2 to 5.0m	2.2 to 5.0m	1.5 to 2.5m	Mixed with motorized vehicular traffic

<sup>16</sup> AASHTO Chapter 4, cross sectional elements

	Arterial Roads	Sub Arterial Roads	Distributory Roads	Access Roads
<b>Minimum Width</b>	2.5 for a two lane cycle track and 1.9m for a common cycle track and footpath	2.0 for a two lane cycle track and 1.7m for a common cycle track and footpath	1.5m	1m (painted)

### 5.3. PEDESTRIAN PATHS

The pedestrian paths should be continuous as well as segregated unless at stretches where narrow right of way rules out the possibility of segregated paths. At such locations visual continuity should be maintained using texture and pavement markings.

Paths should be shaded and space for facilities such as service providers (hawkers), benches, street light poles etc., should be provided outside the pedestrian path, the edge of which needs to be clearly defined.

Benches for the disabled as well as the general public should be provided along the pedestrian path. The spacing of such facilities should be between 18 to 360m, based on the table below.

Table 5-3 Cumulative percentage of mobility impaired people observed to be unable to move more than the stated distance in city centres without rest

	18m	68m	137m	180m	360m
<b>Wheelchair Users</b>	0	5	5	60	85
<b>Visually Impaired</b>	0	0	5	50	75
<b>Ambulant Disabled with walking aid</b>	10	25	40	80	95
<b>Ambulant Disabled without walking aid</b>	5	15	25	70	80

Table 5-4 Pedestrian Paths

	Arterial Roads	Arterial Roads	Distributor Roads	Access Roads
<b>Pedestrian Paths</b>				
<b>Criteria</b>	50 km/h	50 km/h	30 km/h	15 km/h
	50m – 80m	30m – 50m	12m – 30m	6m – 15m
<b>Gradient</b>	1:20	1:20	1:20	1:20
<b>Sight Distance</b>				
<b>Lane width</b>	1.7 (including curbs) to 5.5m each. However where secondary footpaths are available along service lane, the minimum width of secondary paths can be 1.5m (including curbs)	1.7 (including curbs) to 5m each. (including curbs )	1.5 to 3.0m (including curbs) each	0-2.5m (including curbs) each
<b>Effective capacity as per LOS C in persons per/min counted over 15 min</b>		Effective width of footpath (m)		
<b>23-50</b>		1.5		

58-83	2.5
81-116	3.5
115-165	5.0

### 5.3.1. ACCESSIBLE FOOTPATHS

Table 5-5 Components of inclusiveness

<b>Footpath</b>	<b>The minimum clear width should be 1.2m in order to accommodate wheelchair users. Comfortable minimum width is 1.8m. The footpath surface should be even and without any irregularities. The use of guiding and warning blocks should be used.</b>
<b>Paving</b>	The use of guiding and warning blocks should be used along the footpath
<b>Road Markings</b>	It is essential to designate areas in parking lots to make it comply with accessibility standards.
<b>Road Signs</b>	All signs should be visible, clear and consistent. All accessible places should be clearly identified by the International Accessibility Symbol. They should be in contrasting colours. Also, for the visually impaired it is essential to use braille.
<b>Audible Signals</b>	The use of audible signals or auditory signals is beneficial to the visually impaired to cross a road with minimum or no assistance. Also called a pedestrian access system, it is mountable onto signal poles at crossings and a push button system makes its use easier. It also gives an audible alert signal to Vehicle Users about Pedestrian Crossings.

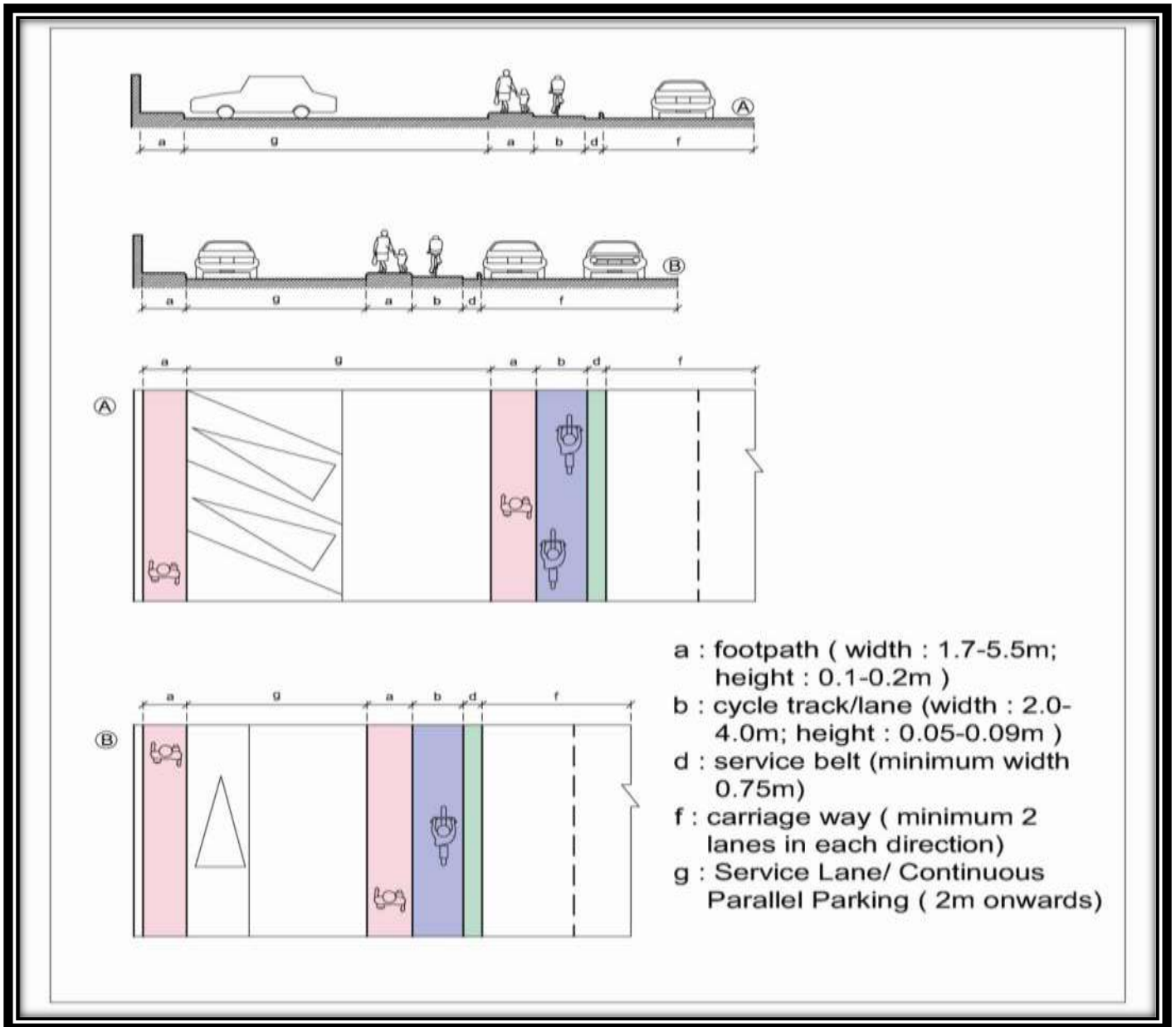

Figure 5-3 Space allocation for Arterial and Sub arterial roads (Standard requirements)

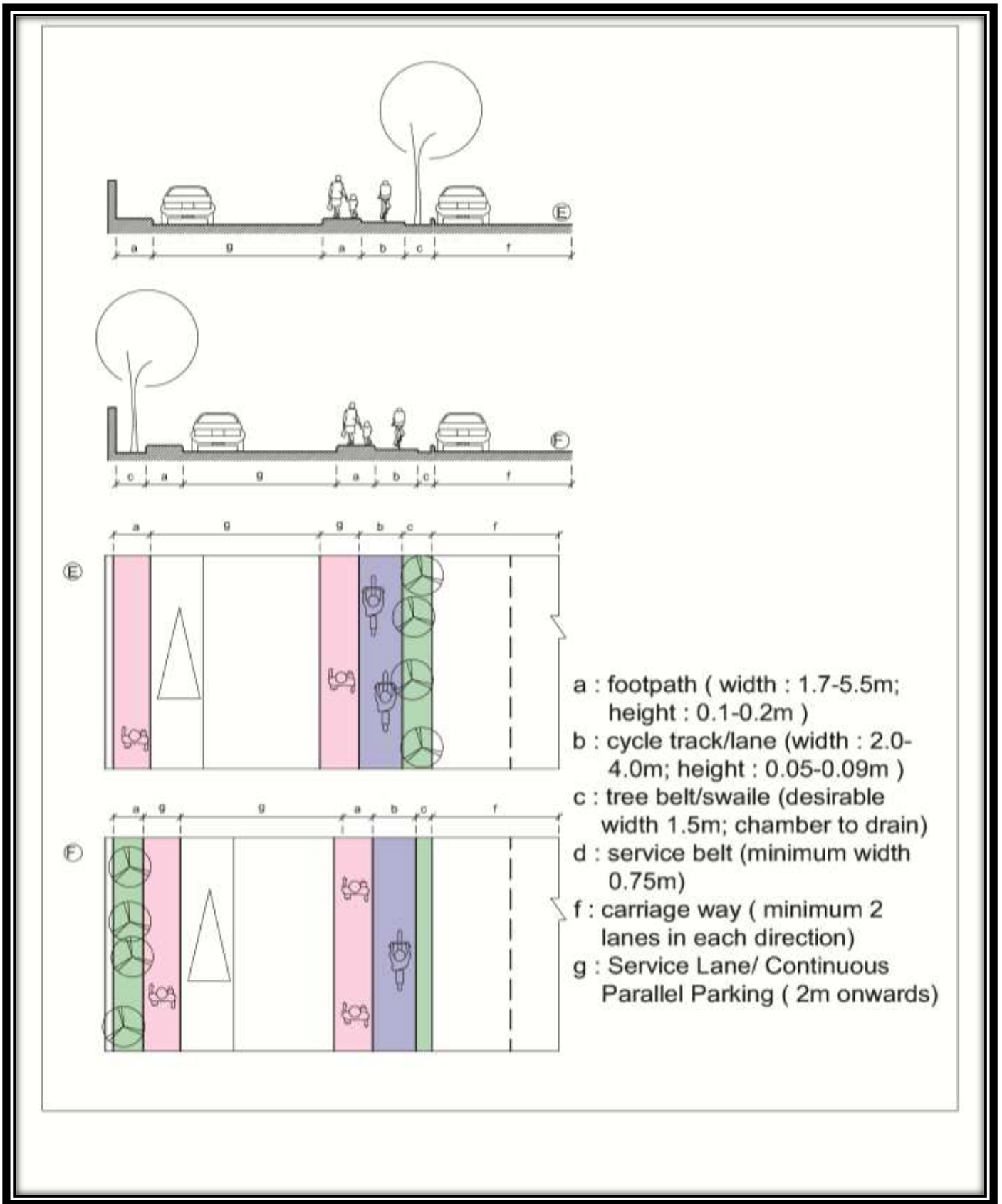

Figure 5-4 Space allocation for Arterial and Sub arterial roads (Standard requirements)



## 5.4. MEDIANS

The divider between the two way traffic lane is called median. In urban areas medians are often used as a pedestrian refuge. Pedestrians can use medians as narrow as 1.2 m but the preferable width is 2 m where space permits. Figure 5-5 shows a typical median having a pedestrian crossing cut with the location of stop line for motorized vehicles.

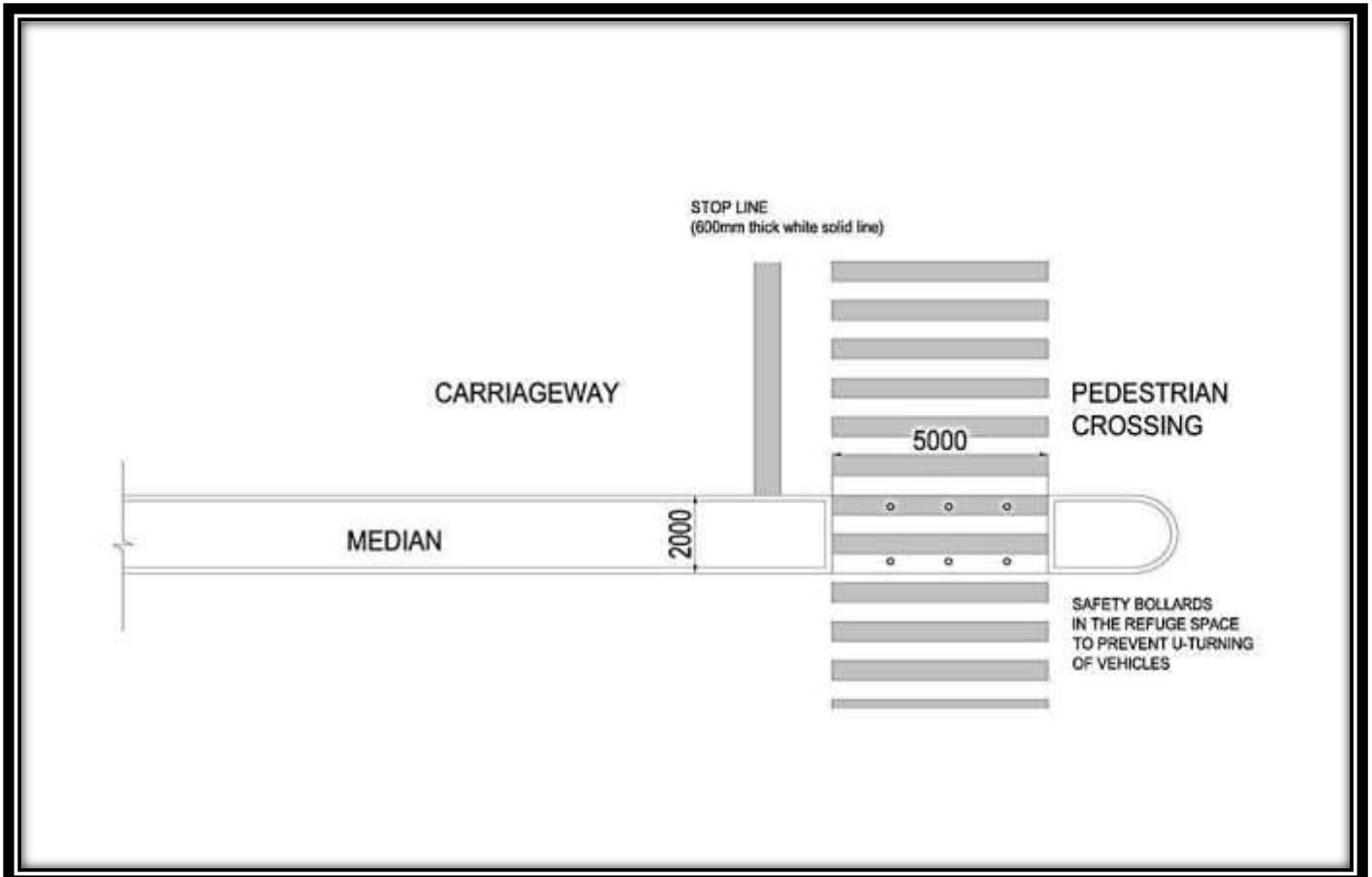

Figure 5-5 Gap in median at pedestrian crossings

## 5.5. SEGREGATORS / CURBS

Segregation between MV lanes and cycle tracks should be designed to allow the cyclists to leave the cycle path wherever necessary.

On streets where fast moving traffic is expected (i.e. peak speeds exceeding 50 km/h) it is desirable to segregate the two lanes by a 0.6 to 0.75m wide median. This can be achieved by using curb stones 0.15m in height.

This segregation may also be used for providing services like storm water collection chambers and light poles. The level of such a surface should be 10 to 25 mm below the carriageway and should be shielded from the carriageway by a single row of 0.15m thick curbstones with a maximum height of 0.15m.

For roads with narrow right of way, the segregation can be limited to 0.15m in height and 0.3m in width. The level of the cycle track may be raised such that the vertical edge from cycle track is only 75 to 50 mm high.

In areas where extremely narrow right of way forces the cycle track to be combined with pedestrian path, the surface should be continuous and should be segregated with a single row of bollards 0.65m high, 0.15m wide and with a maximum clear gap of 1.25m. This arrangement however is not advisable for a continuous stretch of more than 40m.

At places where more than one lane is planned for MV, bicycle lanes should be segregated. These should be separated with the use of white painted stripes on the pavement. A bright or reflective paint should be used to assure optimal visibility for the users of the road.

## 5.6. SERVICE LANES

Service lanes provided on the left of bicycle tracks/lanes help in reducing the number of motorized vehicle conflicts on the bicycle infrastructure. Minor vehicular access to properties, and minor roads is channelized through service lanes reducing the number of punctures on bicycle facility to the bare minimum required for accessing this lane. These are generally spaces at an interval of 200m or more. Most urban roads require provision of parking facilities which can be conveniently integrated with service lanes eliminating conflicts between parked vehicles and bicycle lanes

## 5.7. PARKING

Table 5-6 Parking on different roads

	Arterial Roads		Distributory Roads	Access Roads
<b>Criteria</b>	No parking on main carriageway. Service lanes to be used for parking.	No parking on main carriageway. Service lanes to be used for parking.	Along the carriageway or service lane.	
<b>Any other conditions</b>	Parking may be provided on any one or both sides of the carriageway as per available space. As arterial roads also serve the flow function, it is desirable that parking be limited to dedicated service lanes. Though some conditions may require provision of on street service/emergency parking as well parking for para transit modes, which may be located between carriageway and bicycle track on each side. This provision should not be continuous for distances longer than 40m .	Parking may be provided on any one or both sides of the carriageway as per available space. As arterial roads also serve the flow function, it is desirable that parking be limited to dedicated service lanes. Though some conditions may require provision of on street service/emergency parking as well parking for para transit modes, which may be located between carriageway and bicycle track on each side. This provision should not be continuous for distances longer than 40m .	Parking may be provided on one or both sides of the carriageway as per available space. It should be located between the bicycle/NMV lane and the footpath.	

## 5.8. TREE BELTS / GREEN BELTS/ LANDSCAPED

Tree belt if provided should have a minimum clear width of 0.7m and a desirable width of 1.5m or more on .In general green areas are intended to strengthen the Greens and verges

Landscape development should be in keeping with the character of the road and its environment. Programs include the following general areas of improvement: (1) preservation of existing vegetation, (2) transplanting of existing vegetation where practical, (3) planting of new vegetation, (4) selective clearing and thinning, and (5) regeneration of natural plant species and material.

The objectives in planting or the retention and preservation of natural growth on roadsides are closely related. In essence, they are to provide (1) vegetation that will be an aid to aesthetics and safety, (2) vegetation that will aid in lowering construction and maintenance costs, (3) vegetation that creates interest, usefulness, and beauty for the pleasure and satisfaction of the traveling public, and (4) trees would provide shade and oxygen and use up CO<sub>2</sub>.

### 5.9. BUS SHELTERS

- Bus stops must be located where it is safe and convenient for bus commuters to reach the bus stop. Bus stops locations must minimize the delays faced by commuters (pedestrians) and motorized traffic at junctions. Bus stop platform design should minimize boarding and alighting time.
- A minimum distance of 500 m is recommended between the bus shelters. Shorter distance maybe required for specific locations like schools or offices. The distance between the bus stops should not exceed more than 1 km because access distance for bus commuters exceeds 500 m.
- Bus stop at junction can be located on the near side of the junction or the far side of the junction. Bus stops located on the near side of the junction can utilize red light phase for boarding and alighting and improve the performance of the bus operation.<sup>17</sup> Also when the volume of buses is high, (more than 3bus/signal cycle), queue on the far side bus stop may spill over at the junction. Therefore the near side of the junction is the preferred location for bus stops.
- Bus stop can be located before the junction itself or at some distance away from it. It has been observed that as a bus shelter is brought nearer to a junction the flow of traffic improves. However it also increases interference with turning traffic. It has been found in simulation experiments that bus shelters located at 20m before the junction give the best results.
- On distributory and access roads bus shelters can be on the far side of the junction because the volume of buses is not as high as on the arterial roads.
- If the distance between the junctions is more than a km, bus stops have to be provided at the mid blocks. This should be combined with pedestrian signal to ensure safe crossing for bus commuters.

### 5.10. OTHER FEATURES – STREET FURNITURE & SUPPORT FACILITIES

All Indian cities experience street vendors operating on major roads and they are important service providers for road users especially for bus commuters, bicyclists and pedestrians. They are often found as a consequence of the demand generated on the street. Usually, they are found occupying the footpath or the left most lane of the carriageway, which affects those who use

<sup>17</sup> TRIPP, student simulation project

this facility. In such cases, the pedestrians or cyclists (riding in the left most lane in the carriageway) are pushed toward the median creating conflict between the fast moving traffic and other road users..

Integrating the road infrastructure with designed hawker spaces reflects a safer and ordered design. Their presence also ensures safety.

Cycle rickshaw parking and three wheeler parking bays of 1.5m width should be provided near the junctions. This allows for better modal integration. Parking bays also reduce friction for moving vehicles. Hawkers provide essential service to bus commuters, cyclists and pedestrians. Space for hawkers can be integrated with three wheeler and rickshaw parking and junction corners where pedestrians wait for traffic signals. If hawker spaces are integrated with the pedestrian waiting areas then the carriageway is left free for moving vehicles.

---

### 5.11. HAWKER SPACES

**Location.** The location of the designated space should be such that the spill over of activities or clientele does not start encroaching the cycle track. The ideal location is integrating the space after allocating space for the carriageway, lanes/tracks and pedestrian paths. The hawkers can then be integrated along the pedestrian path. It is very rarely seen that mainstream cyclists use these facilities. However, additional spaces could be near Auto rickshaw/ short-term bays for cars that are clearly distinct from the other lanes/tracks/infrastructure.

**Type.** The types of hawkers are the same that have been identified from the land use survey. Also, the design could answer the need of areas that would enhance the urban quality of the roads with landscapes and other street furniture. This way, the area of collection / activity would be concentrated and limiting.

**Material.** The use of material can be the same as that of the pedestrian path or a mix of materials can be used to evolve a pattern in the paving. The designer should keep in mind that it should be attractive enough for vendors to use it. The material should ensure no hindrance in drainage. (It could be designed as a habitat area with the designated space as a special location)

**Edge treatment.** It should be at the same level as the pedestrian path.

It can be segregated from the pedestrian path either by providing bollards spaced at a clear distance of 1.25 – 1.3m or by providing different texture/ flooring pattern that demarcates the space from the main pedestrian path.

Not only does the line of bollards serve the purpose of segregation, it also prevents the three-wheelers from using the available space for parking.

The design of the bollard has been left to the discretion of the designer in order to make this space more attractive.

The edges could be designed using street furniture like benches and bollards. The use of a dual use space has already been discussed above.

**Change in elevations.** It would not be wise to segregate levels in case the area is small. Hawkers and vendors would like to be as close to their clients and a change in level from the pedestrian path would not ensure a fluid movement of their clientele. A visual segregation works best in such cases since it is also easier to demarcate territory, in case regulations are to be enforced.

**Access.** The space should be easily accessible by all types of hawkers. Some of the hawkers use bicycles and wheeled-carts. To ensure they are able to access such spaces, a mountable kerb could be designed. Another provision would be the use of ramps provided for level access for the differently-abled for using the feeder infrastructure.

## 5.12. STREET FURNITURE

Furniture in the external environment consists of a diversity of elements such as light standards, seats, picnic tables, bins, information panels, traffic signs, parking meters and post boxes etc, often placed independently over time and without co-ordination. In urban environments the complexity of the layering of these elements can result in an obstacle course for most persons, particularly for persons with visual impairments and those using a wheelchair or pushing a buggy.

### Placing

In both rural and urban situations, place furniture **out of the line of movement**, so that persons do not bump into it. Good placing and coordination of furniture will result in a tidy, legible pathway or street that is easy to move along. Elements should be placed in **straight lines**.

For instance, light standards define the main zone of objects in a street and bollards, traffic signs and post boxes can follow this line. Bulky objects such as post boxes should not be placed where they will become a visual obstruction at crossing points. The line of furniture should allow a **clear circulation corridor of 1800mm**, minimum 1200mm, wide. This dimension allows a wheelchair user and a pedestrian to pass each other without having to give way.

### Need for resting places/seats

Elderly and disabled pedestrians need to rest at reasonably frequent intervals. Provision of resting places - simple sitting areas with chairs, benches or steps where one can have a break - is an important element of pedestrian spaces.

As with all street furniture, seating should be placed next to the footway without obstructing it, and painted in contrasting colours. Seats can be as simple as wooden benches or perch-type rails to lean against.

Seats should be 480mm high and painted to contrast with the surroundings.

Along frequently used pedestrian ways, seating should be provided at regular intervals, typically every 50metres.

In commonly used pedestrian areas, such as the one access audited, resting places should be provided at intervals not greater than 100m at strategic points.

It is helpful to people with sight problems if these and other amenity areas adjacent to walkways and pedestrian routes are picked out in contrasting colors.

People who can walk, but with difficulty, are often more limited in the distance they can travel than are people in wheelchairs.

The percentage of people with various impairments who can, with assistance; walk various distances<sup>18</sup> is shown in table 5-7.

<sup>18</sup> Inclusive Mobility Guidelines, UK

Table 5-7 Percentage of people able/ with assistance move at least the stated distance without a rest

Impairment Groups	Distance				
	18m	68m	137m	180m	360m
Wheelchair users	100%	95%	95%	40%	15%
Visually impaired	100%	100%	95%	50%	25%
Stick users	90%	75%	60%	20%	5%
Ambulatory without walking aid	95%	85%	75%	30%	20%

Table 5-8 Recommended walking distance limit without a rest for people with various impairments

Impairment Group	Recommended distance limit without a rest
Wheelchair users	150m
Visually impaired	150m
Stick users	50m
Ambulatory without walking aid	100m

### Colour and contrast

Furniture should contrast in colour and in tone with the background against which it is seen and should be highlighted by means of a **75–100mm high feature**, such as a crest or band, which contrasts in colour and tone with the furniture itself.

Furniture should be **continuous to ground level**. Avoid pedestal-mounted objects such as litter bins, telephones or letter boxes. Items attached to posts should face in the direction of travel so that they do not interfere with the line of movement. Where eye-level signs, such as maps, are supported on two vertical poles, a **tapping rail** located between the posts at around 250mm above ground level prevents an unsuspecting pedestrian colliding with the sign. The rail and posts should be colour contrasted with their background.

## 5.13. CROSS SECTIONS

It is important to understand that the spatial arrangement as well as allocation of the elements based on the function, design speed of the road and the ROW of the road eventually governs the design of the cross section of the Road.

Table 5-9 Cross Section types of varying ROWs

S.NO.	Cross Section Type
1.	FIGURE 5-7 CROSS SECTION ARTERIAL ROAD
2.	FIGURE 5-8 PLAN AND SECTION –DISTRIBUTORY ROAD
3.	FIGURE 5-9 CROSS SECTION –ACCESS ROAD (ROW 12 -30M, DESIGN SPEED 3KMPH)
4.	FIGURE 5-10 CROSS SECTIONS FOR DIFFERENT ROWs (38.60 M TO 57.00M)
5.	FIGURE 5-11 CROSS SECTIONS FOR DIFFERENT ROWs (42.60M TO 60.20M)35
6.	FIGURE 5-12 CROSS SECTIONS FOR DIFFERENT ROWs (55.70M TO 71.80M)
7.	FIGURE 5-13 CROSS SECTIONS FOR DIFFERENT ROWs (48.30M TO 62.50M)
8.	FIGURE 5-14 CROSS SECTIONS FOR DIFFERENT ROWs (45.00M TO 61.30M)
9.	FIGURE 5-15 CROSS SECTIONS FOR DIFFERENT ROWs (38.60M TO 52.20M)
10.	FIGURE 5-16 CROSS SECTIONS FOR DIFFERENT ROWs (47.60M TO 71.70M)
11.	FIGURE 5-17 CROSS SECTIONS FOR DIFFERENT ROWs (42.40M TO 66.50M)
12.	FIGURE 5-18 CROSS SECTIONS FOR DIFFERENT ROWs (38.40M TO 57.50M)

- 13. FIGURE 5-19 CROSS SECTIONS FOR DIFFERENT ROWs (43.50M TO 62.70M)
- 14. FIGURE 5-20 CROSS SECTIONS FOR DIFFERENT ROWs (41.50M TO 49.49M)
- 15. FIGURE 5-21 CROSS SECTIONS FOR DIFFERENT ROWs (24.00M TO 39.00M)
- 16. FIGURE 5-22 CROSS SECTIONS FOR DIFFERENT ROWs (49.00M TO 62.40M)
- 17. FIGURE 5-23 CROSS SECTIONS FOR DIFFERENT ROWs (42.60 M TO 60.20M)
- 18. FIGURE 5-24 CROSS SECTION –ROW 45M
- 19. FIGURE 5-25 CROSS SECTION –ROW 75M

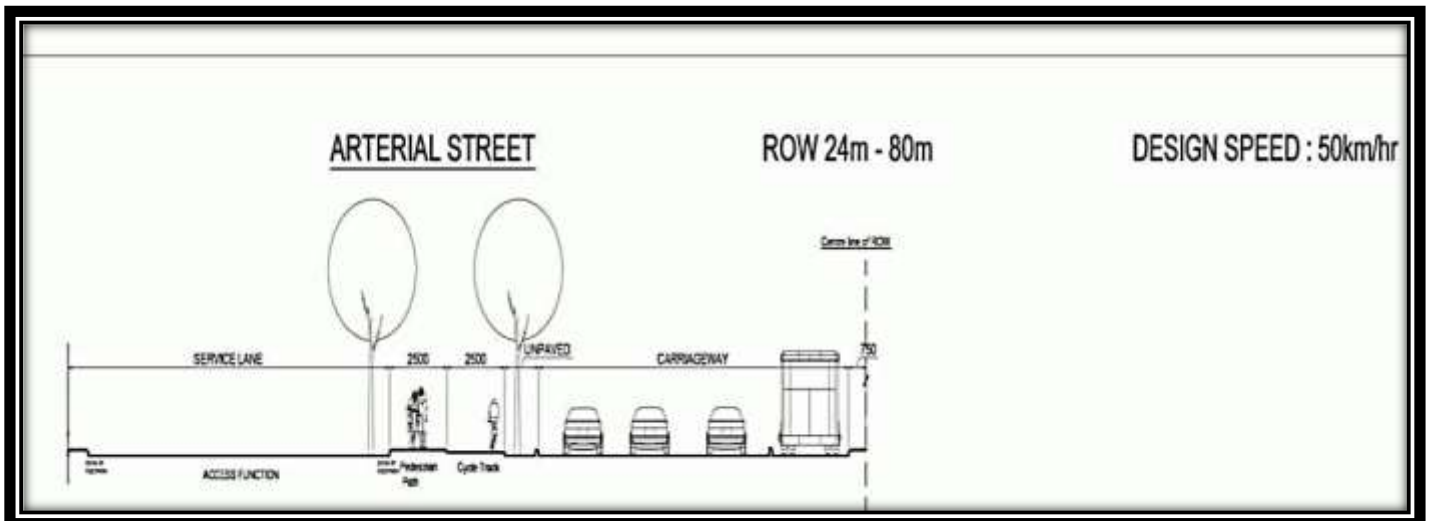

Figure 5-6 Cross Section Arterial Road

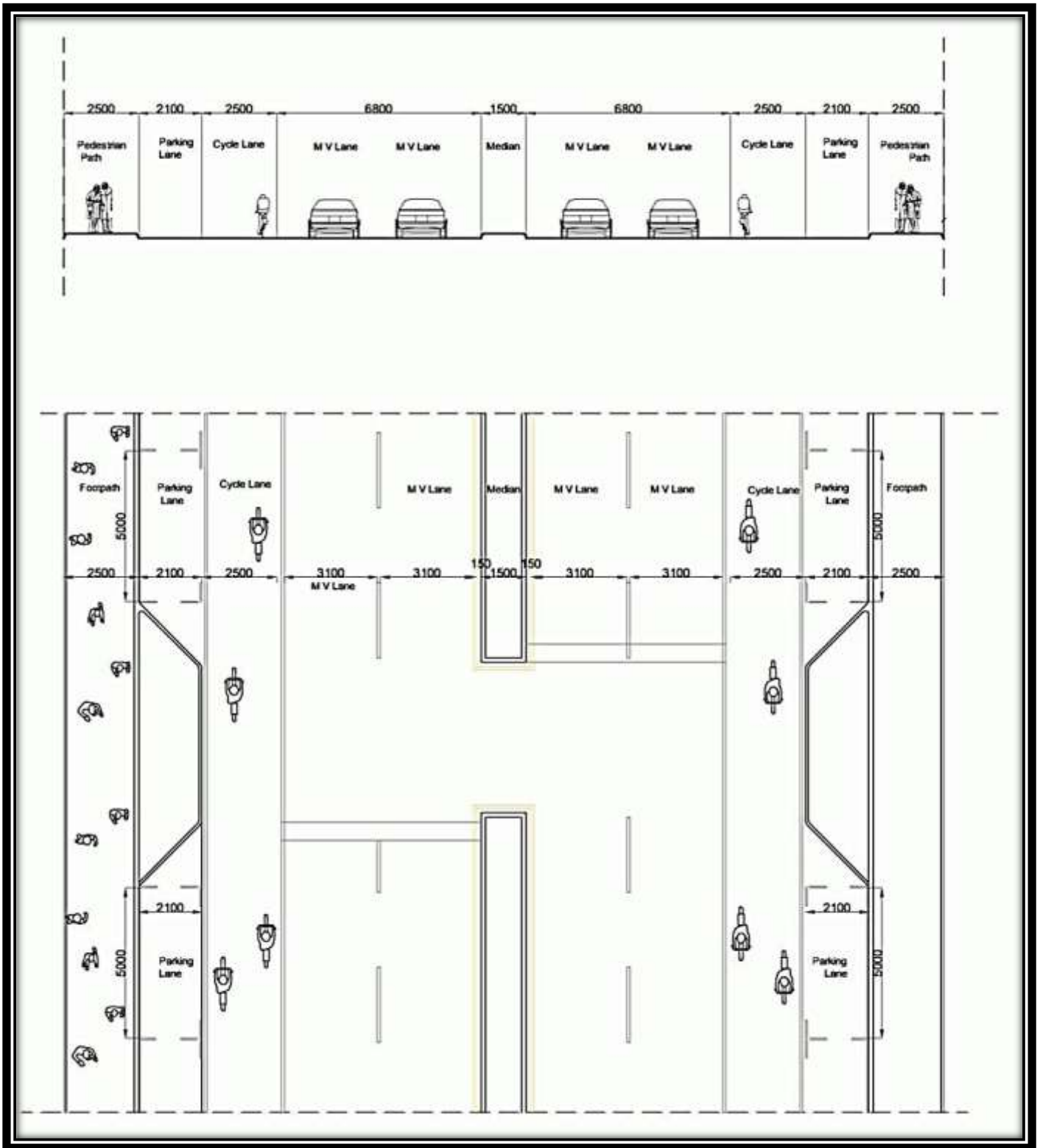

Figure 5-7 Plan and Section –Distributory Road



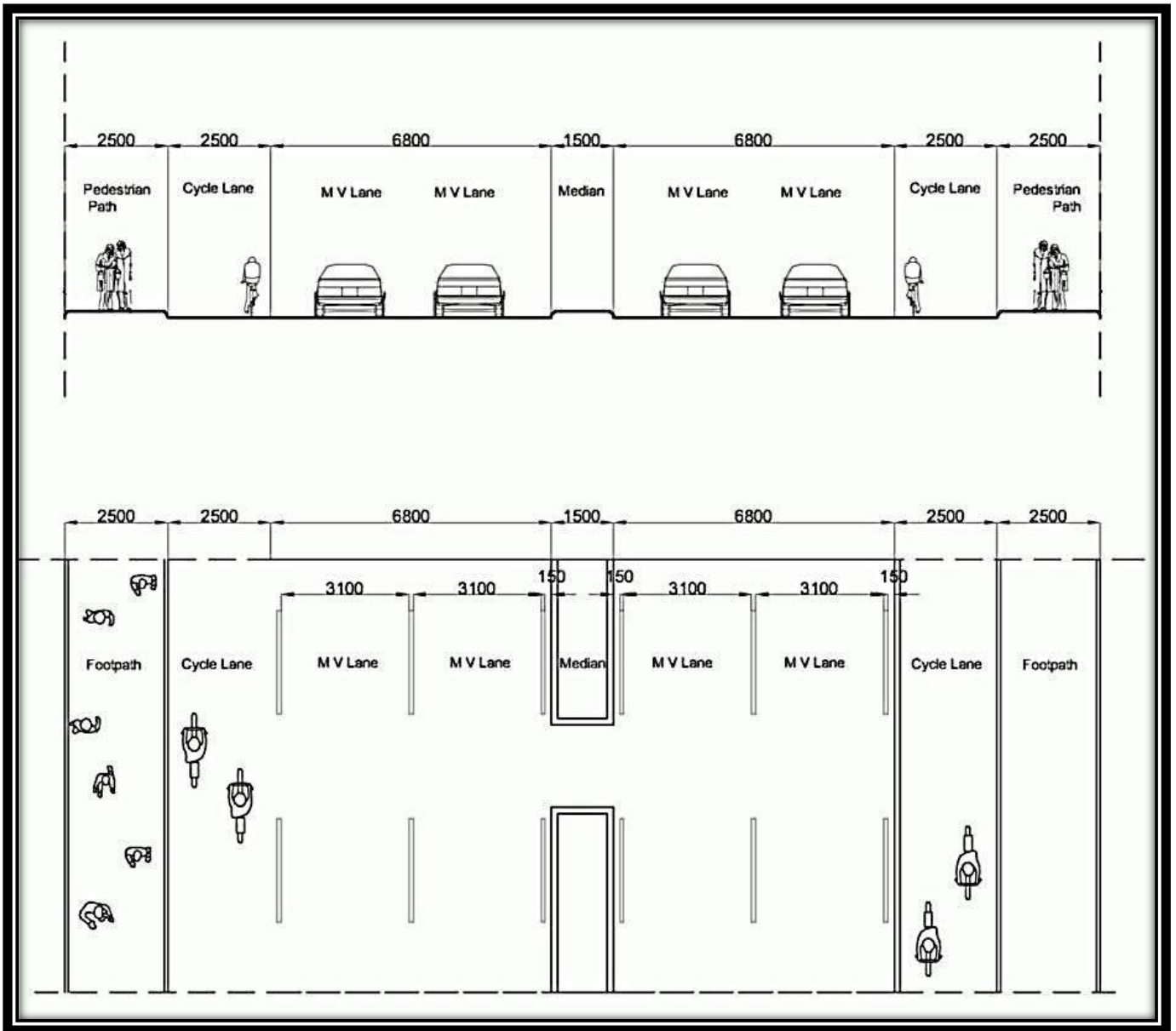

Figure 5-8 Cross Section –Access Road (ROW 12 -30m, Design Speed 3kmph)

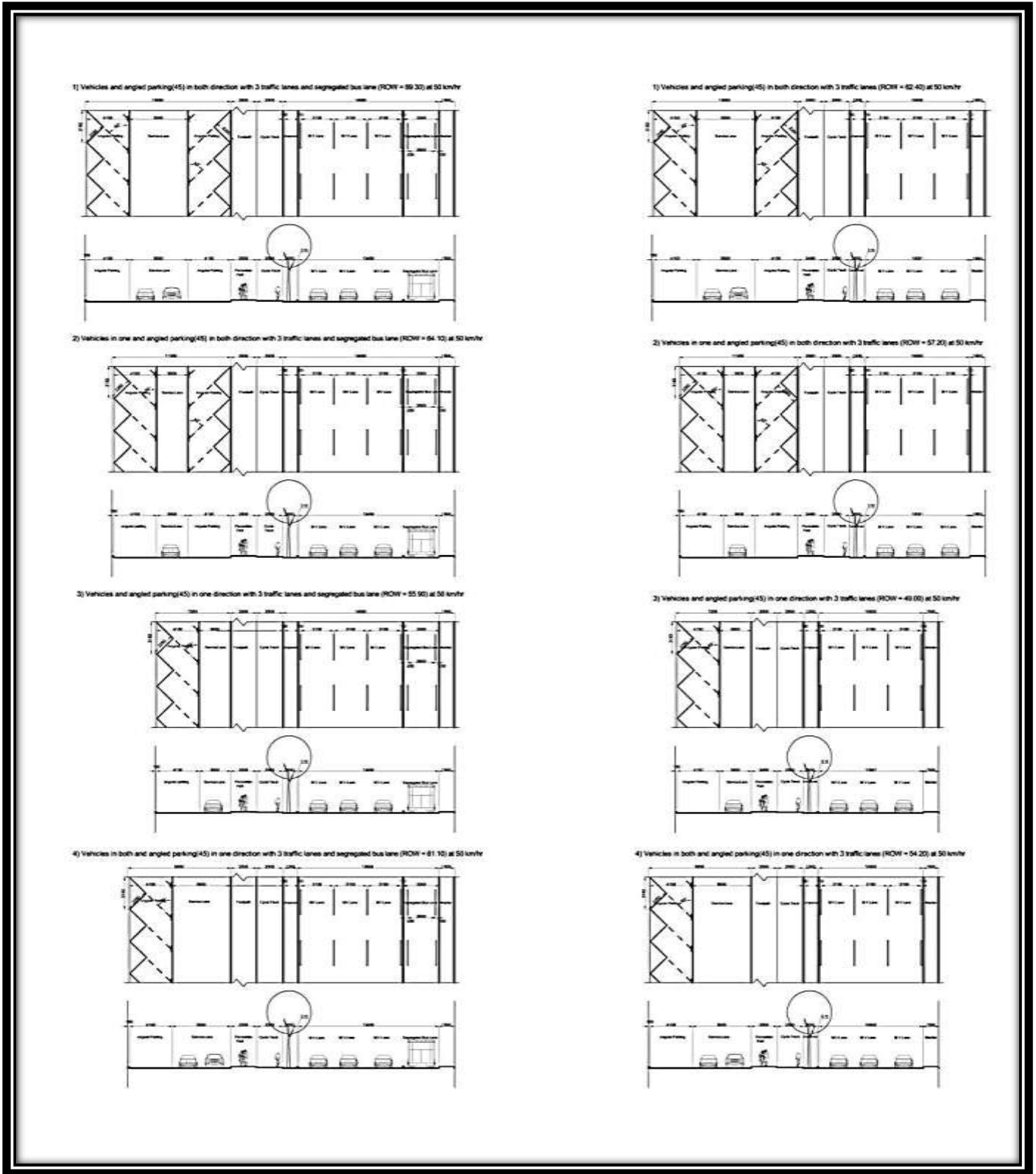

Figure 5-9 Cross Sections for different ROWs (38.60 m to 57.00m)

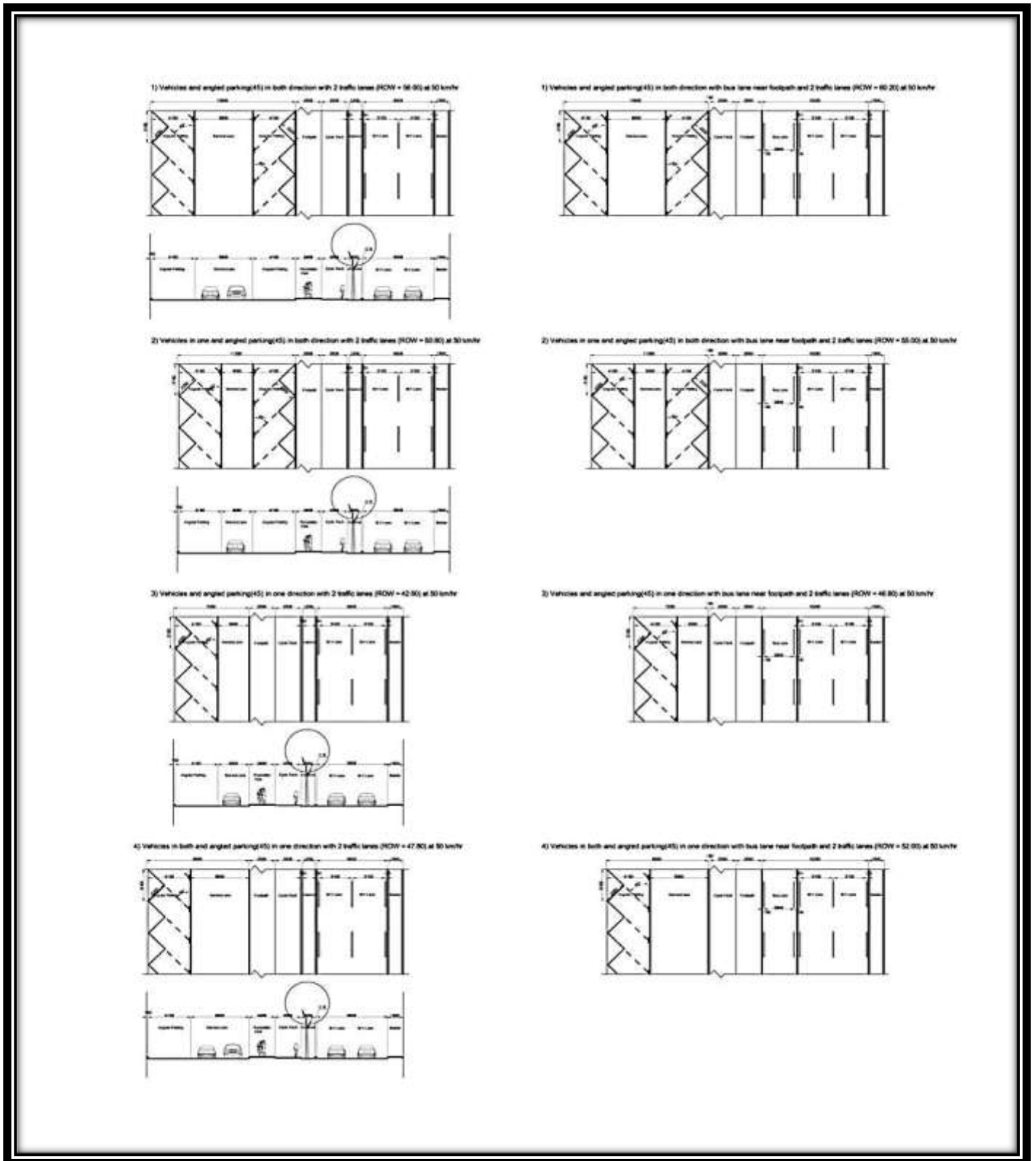

Figure 5-10 Cross Sections for different ROWs (42.60m to 60.20m)

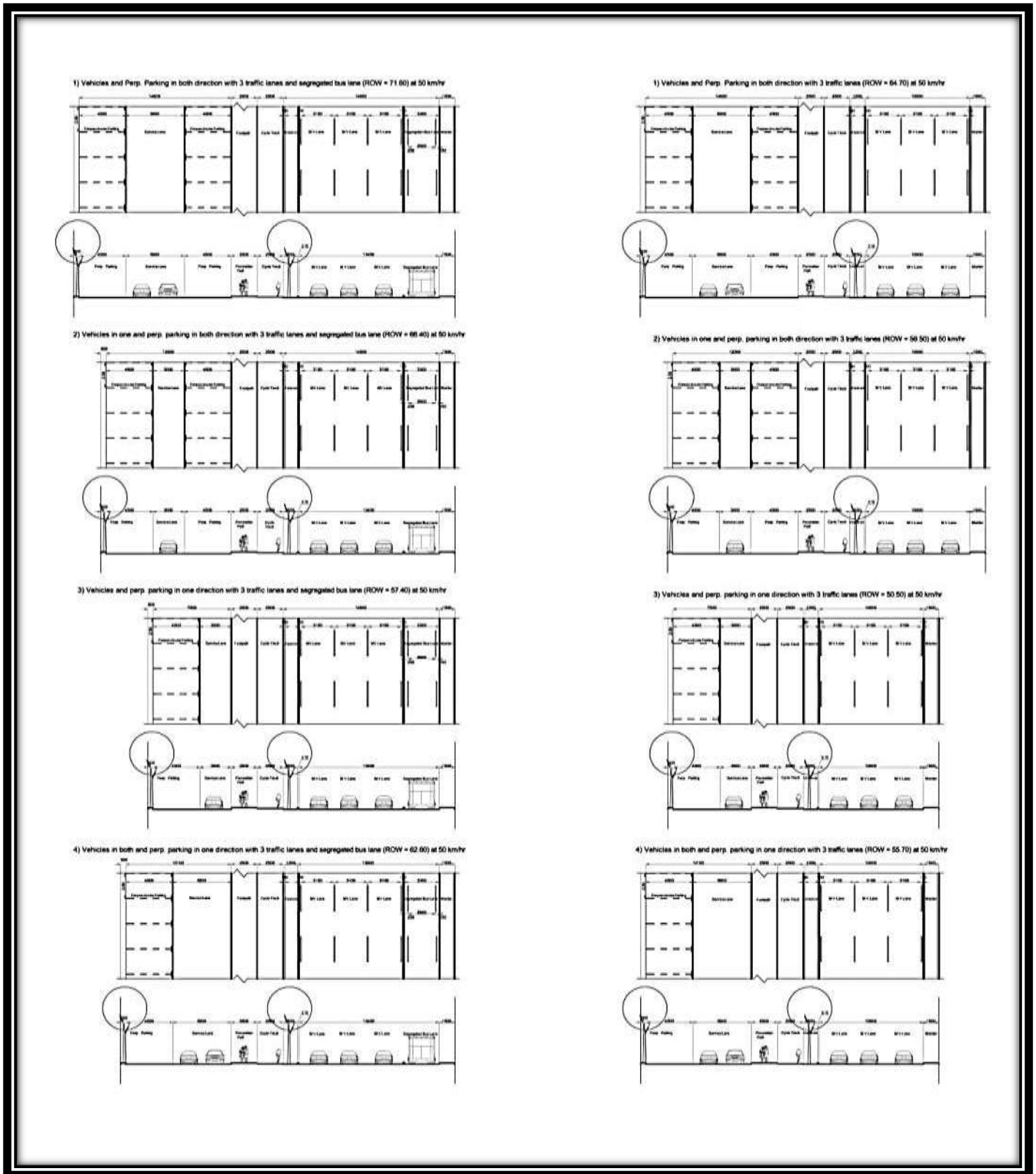

Figure 5-11 Cross Sections for different ROWs (55.70m to 71.80m)

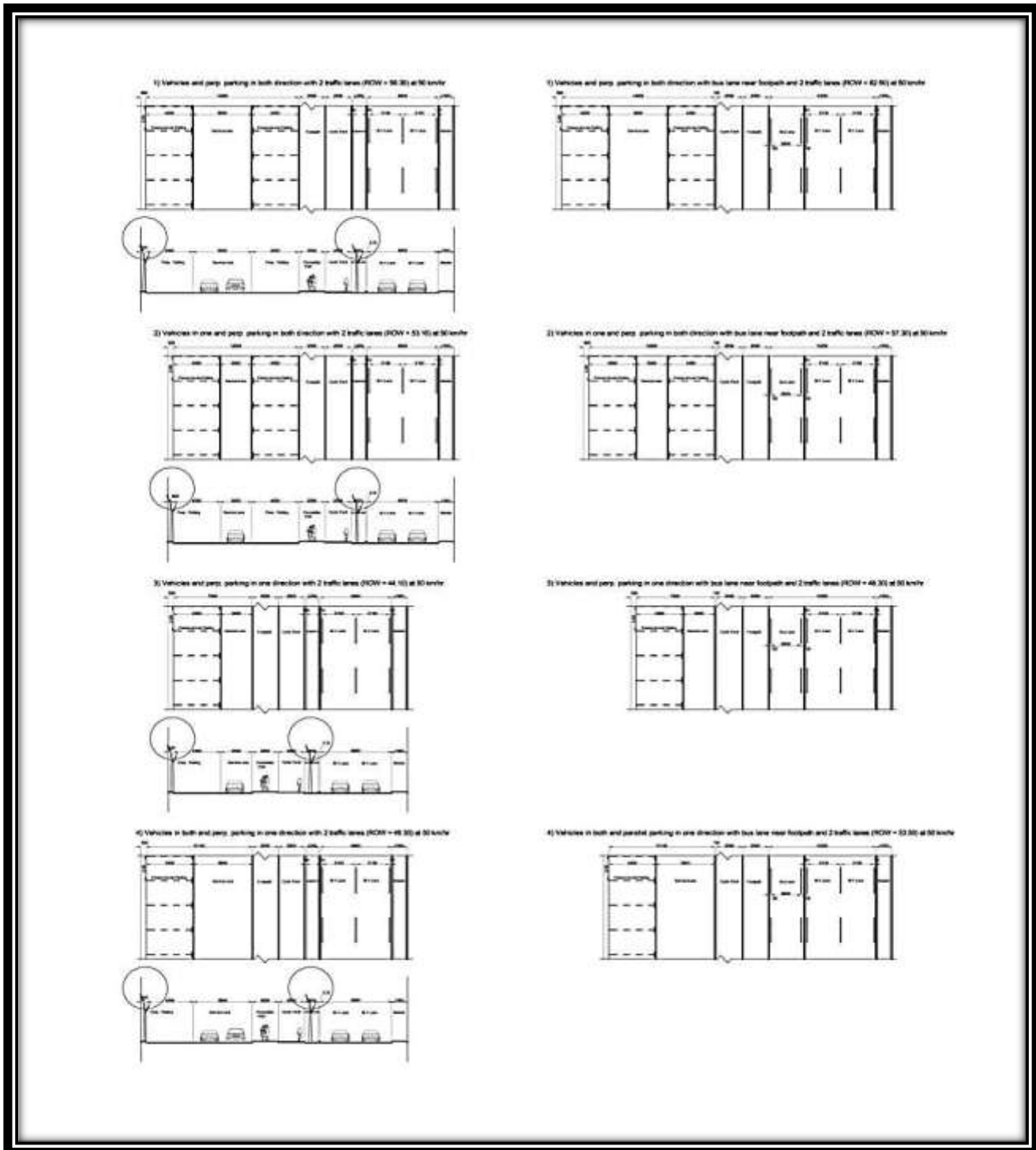

Figure 5-12 Cross Sections for different ROWs (48.30m to 62.50m)



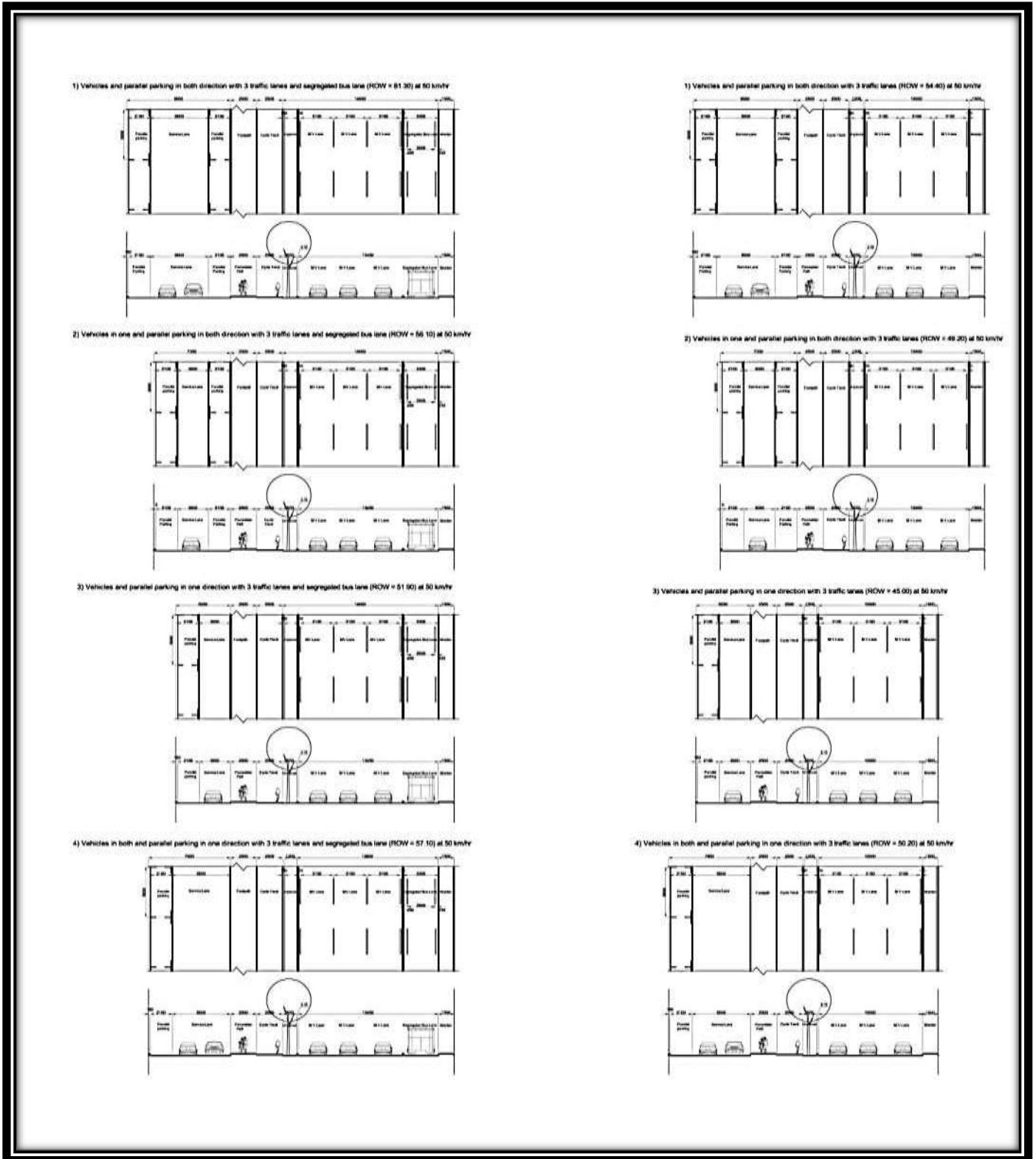

Figure 5-13 Cross Sections for different ROWs (45.00m to 61.30m)

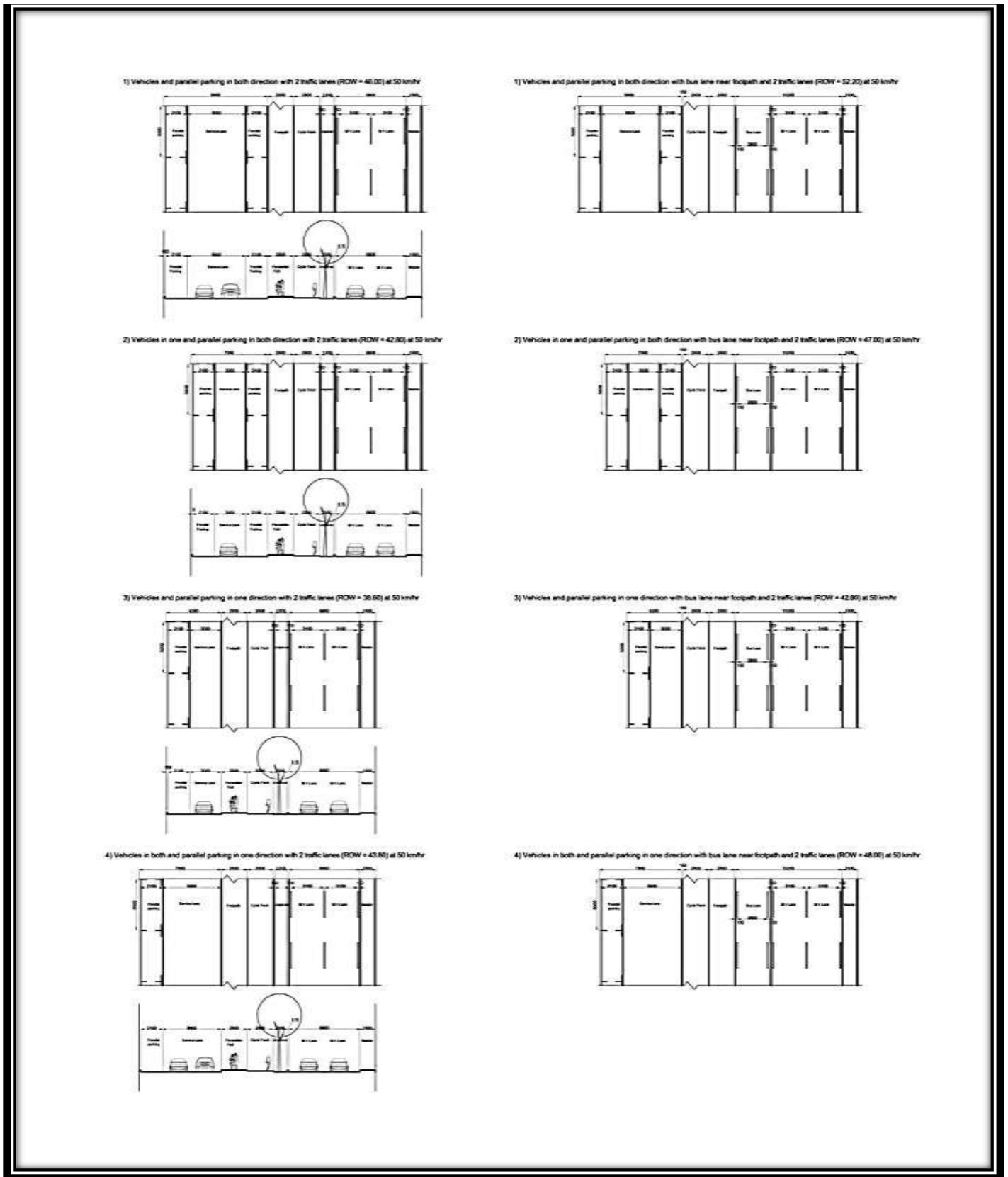

Figure 5-14 Cross Sections for different ROWs (38.60m to 52.20m)

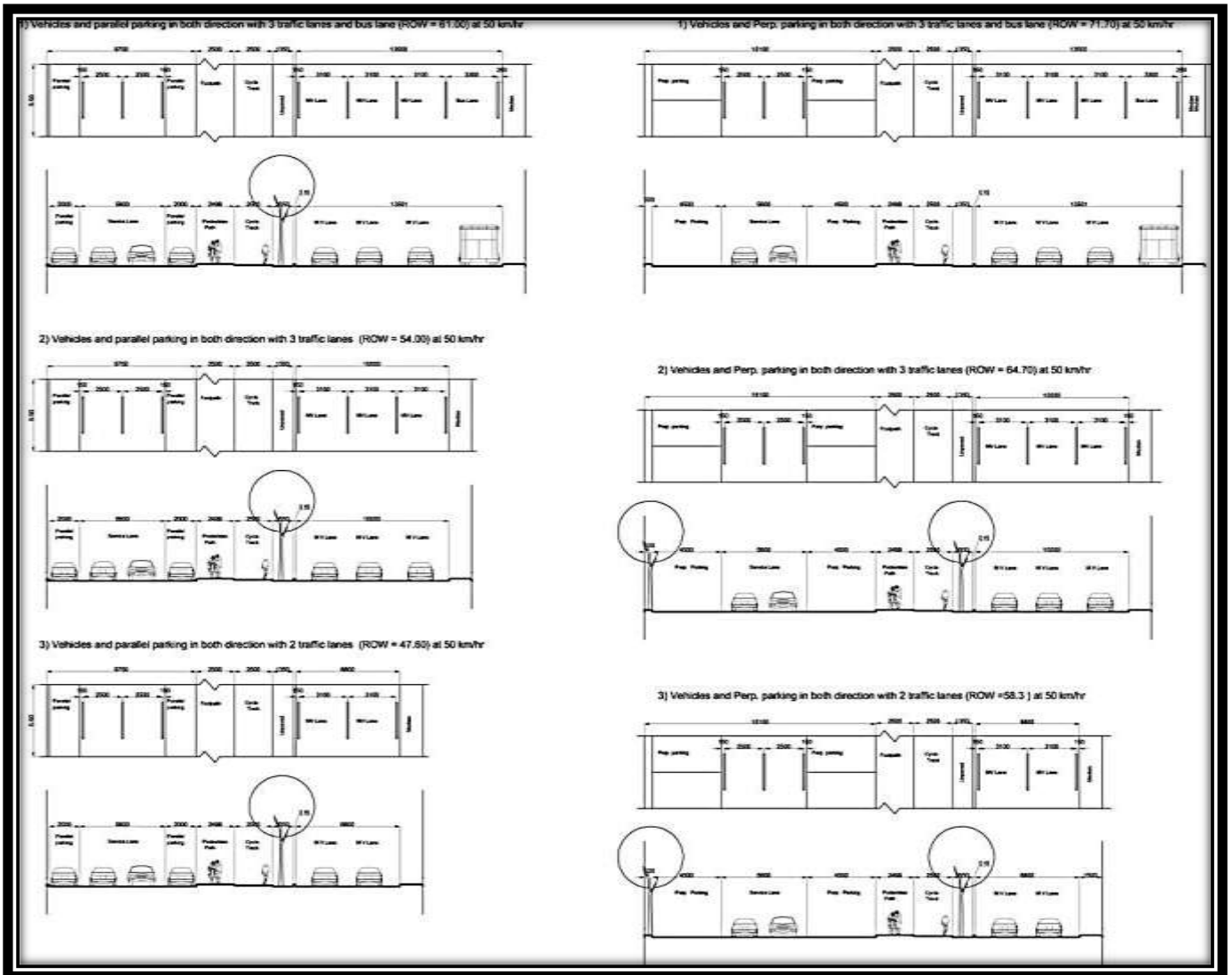

Figure 5-15 Cross Sections for different ROWs (47.60m to 71.70m)



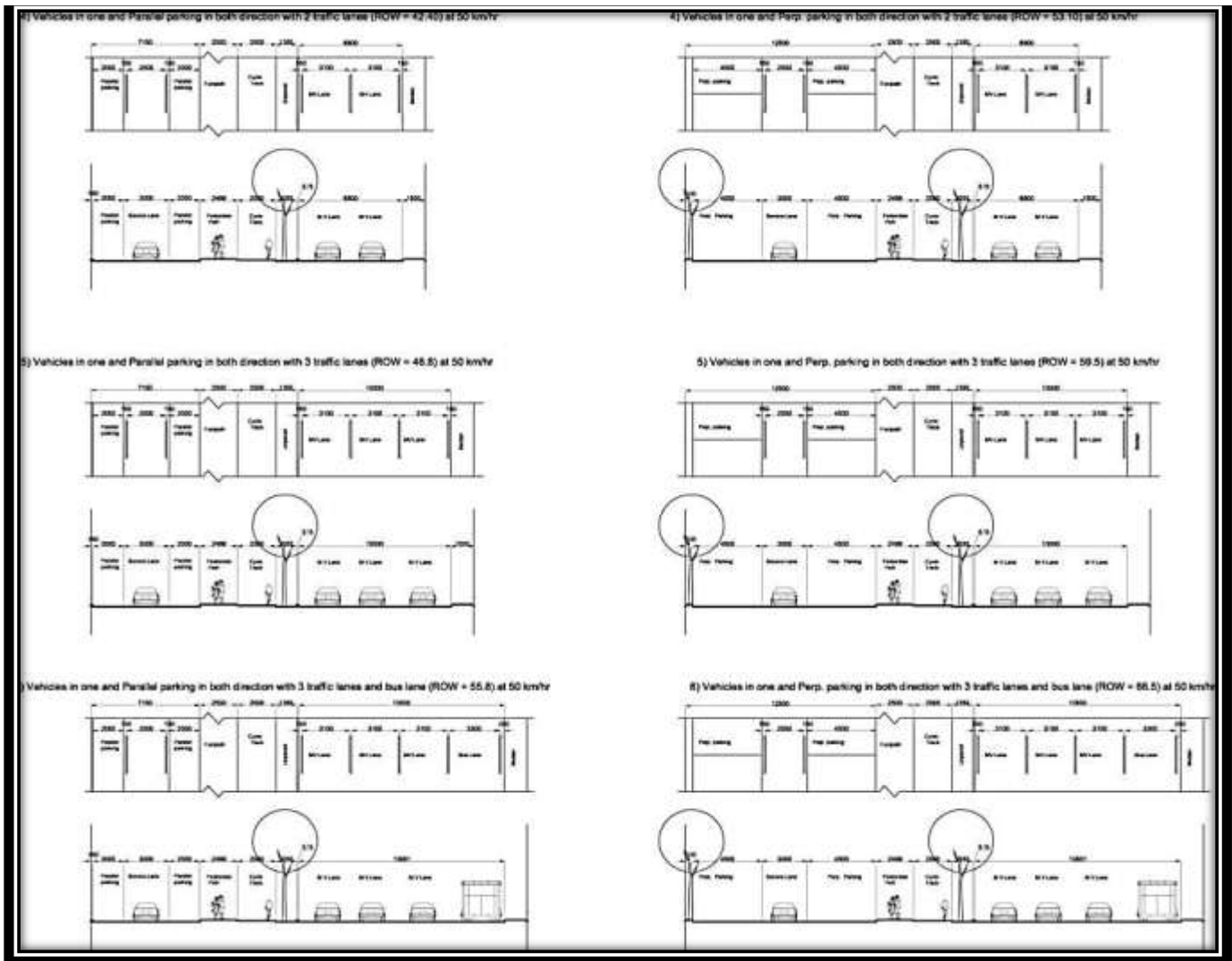

Figure 5-16 Cross Sections for different ROWs (42.40m to 66.50m)

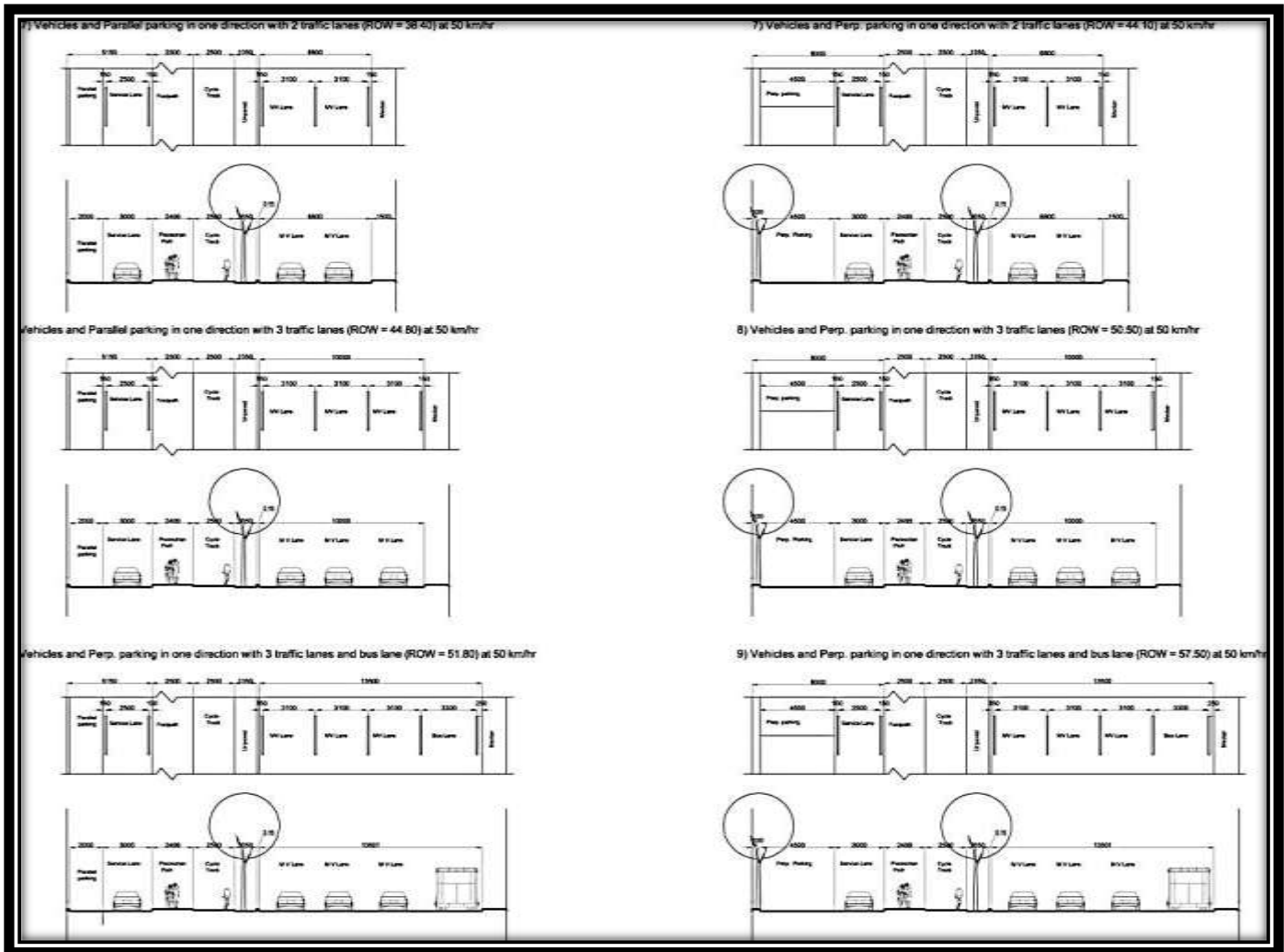

Figure 5-17 Cross Sections for different ROWs (38.40m to 57.50m)

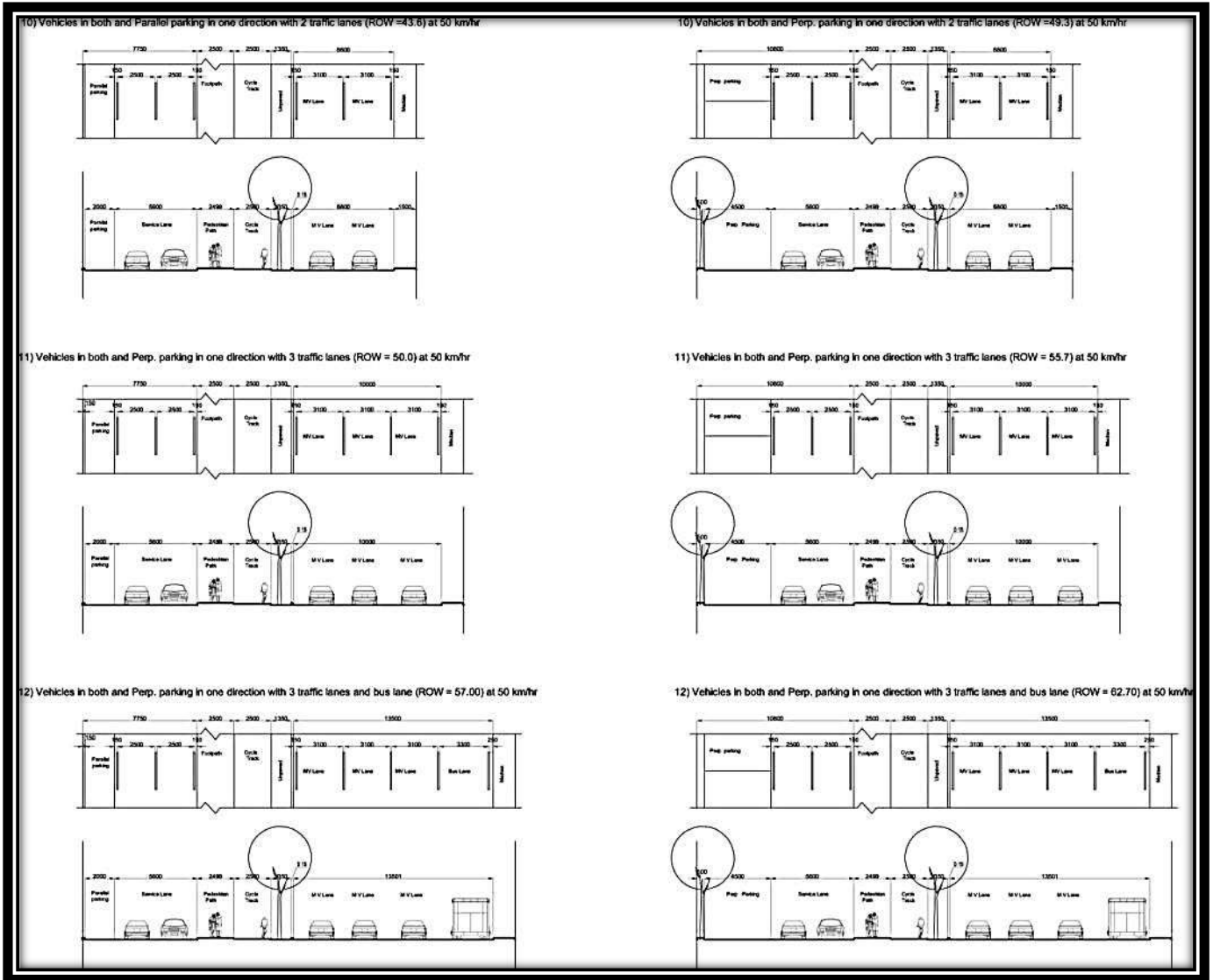

Figure 5-18 Cross Sections for different ROWs (43.50m to 62.70m)

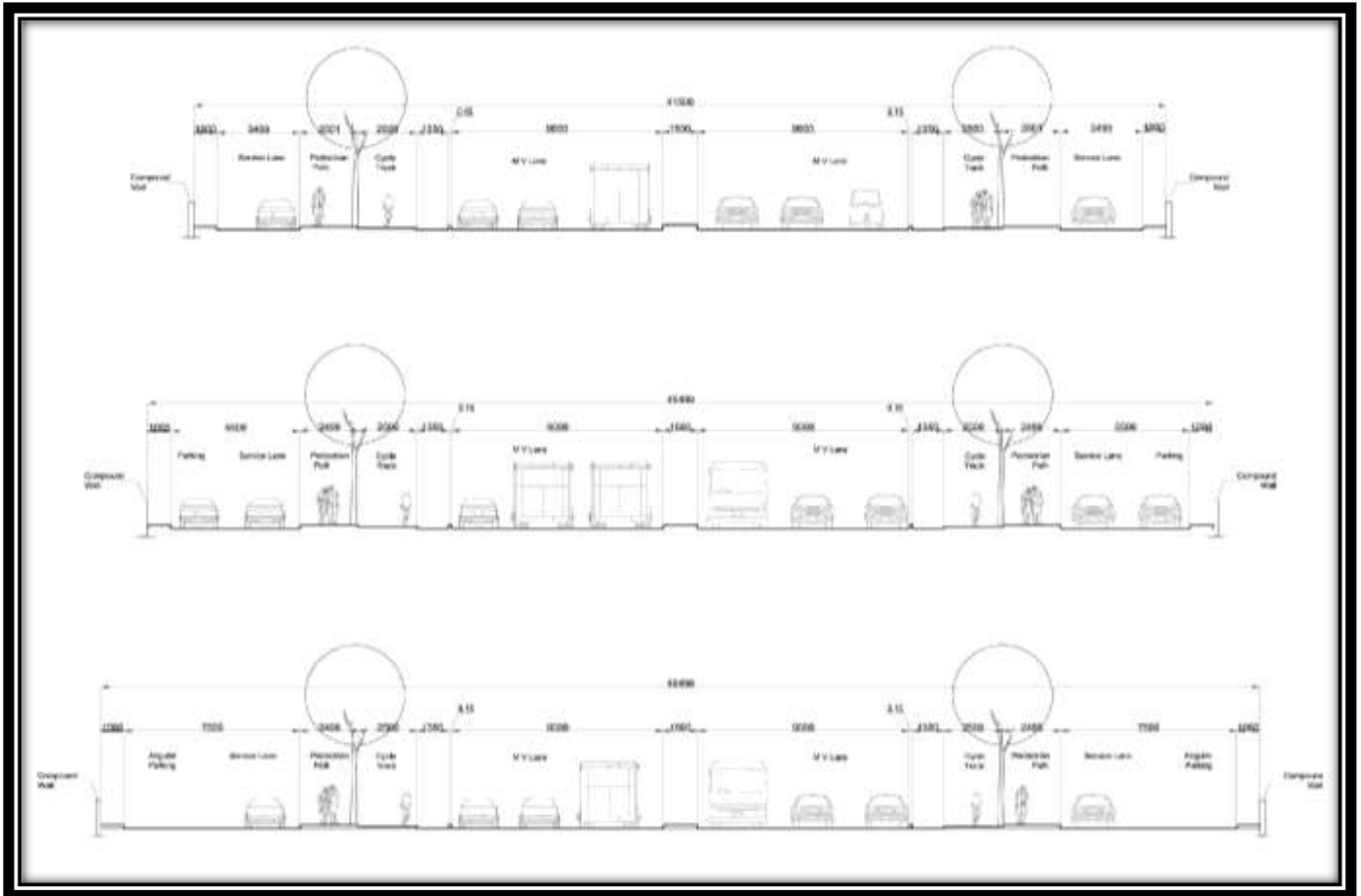

Figure 5-19 Cross Sections for different ROWs (41.50m to 49.49m)

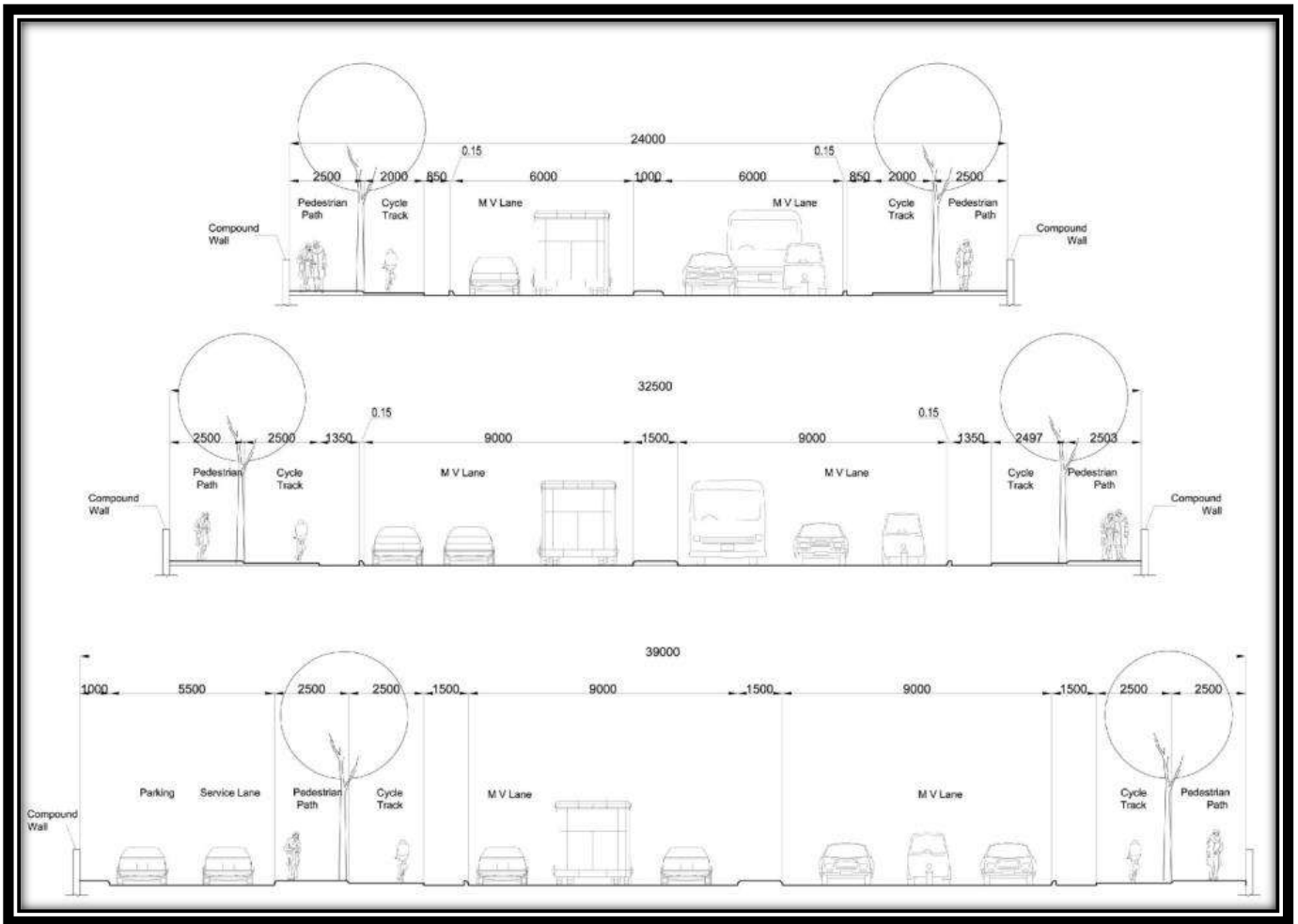

Figure 5-20 Cross Sections for different ROWs (24.00m to 39.00m)

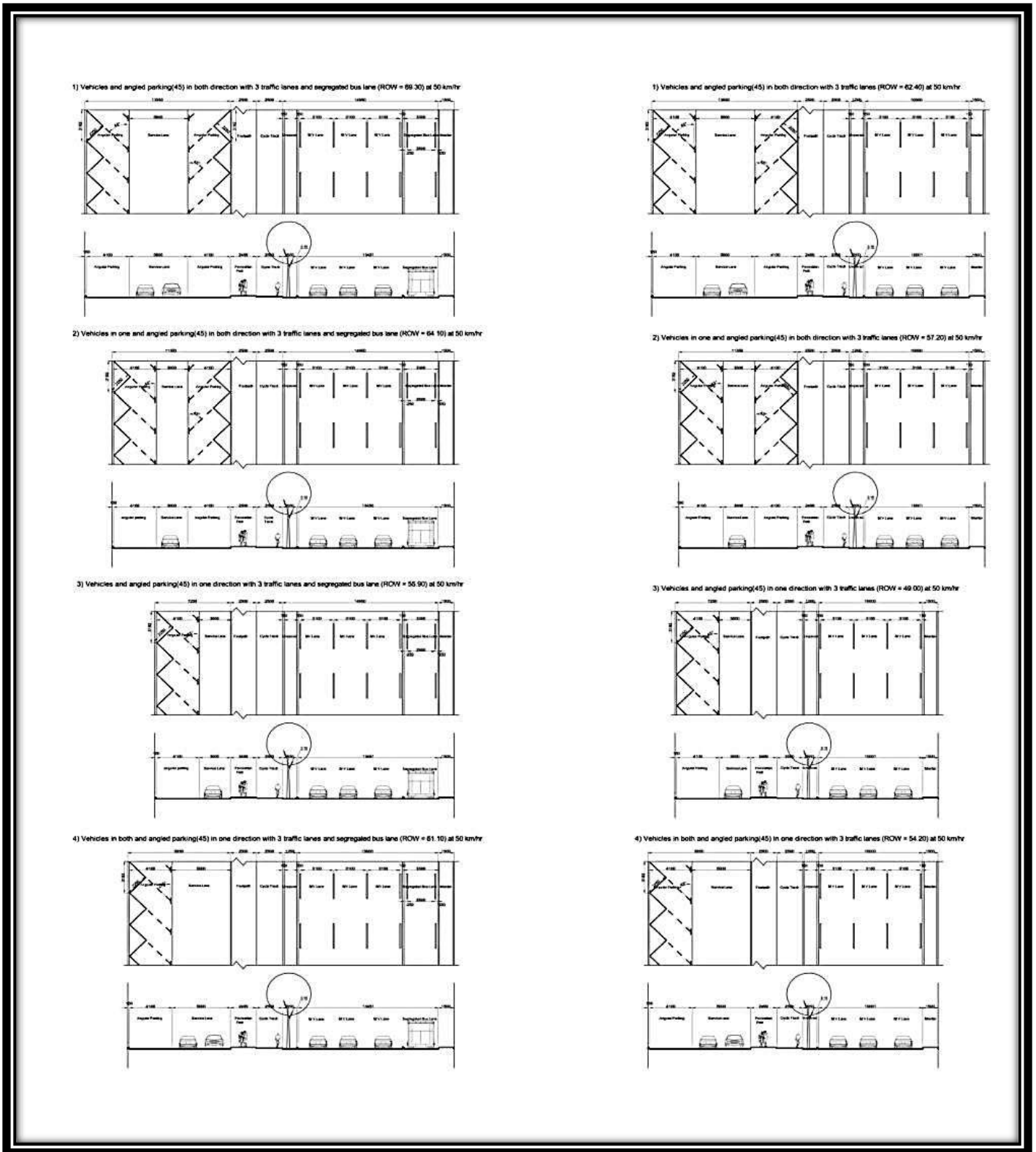

Figure 5-21 Cross Sections for different ROWs (49.00m to 62.40m)



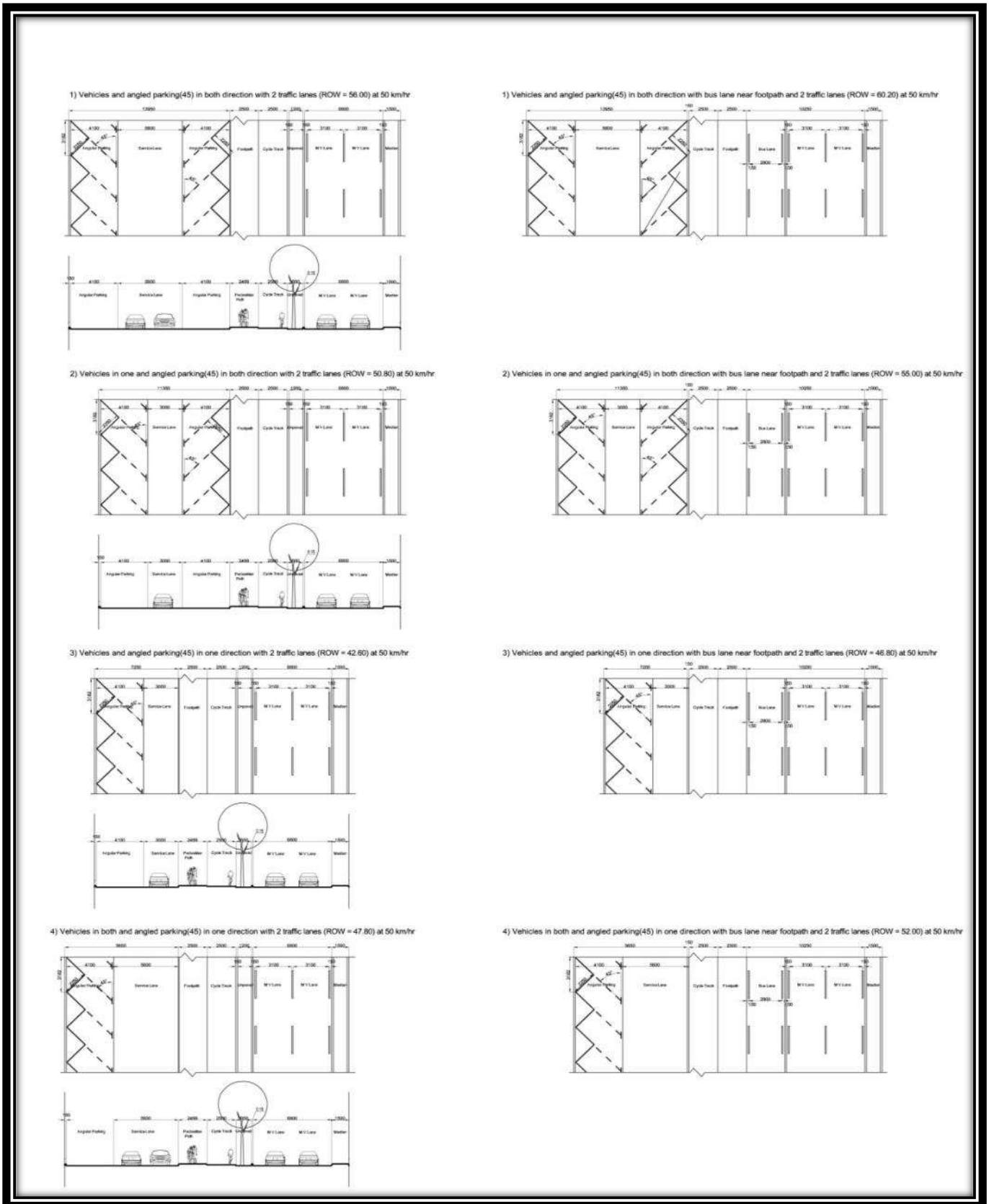

Figure 5-22 Cross Sections for different ROWs (42.60 m to 60.20m)

Examples from Different cities in India for different ROWs

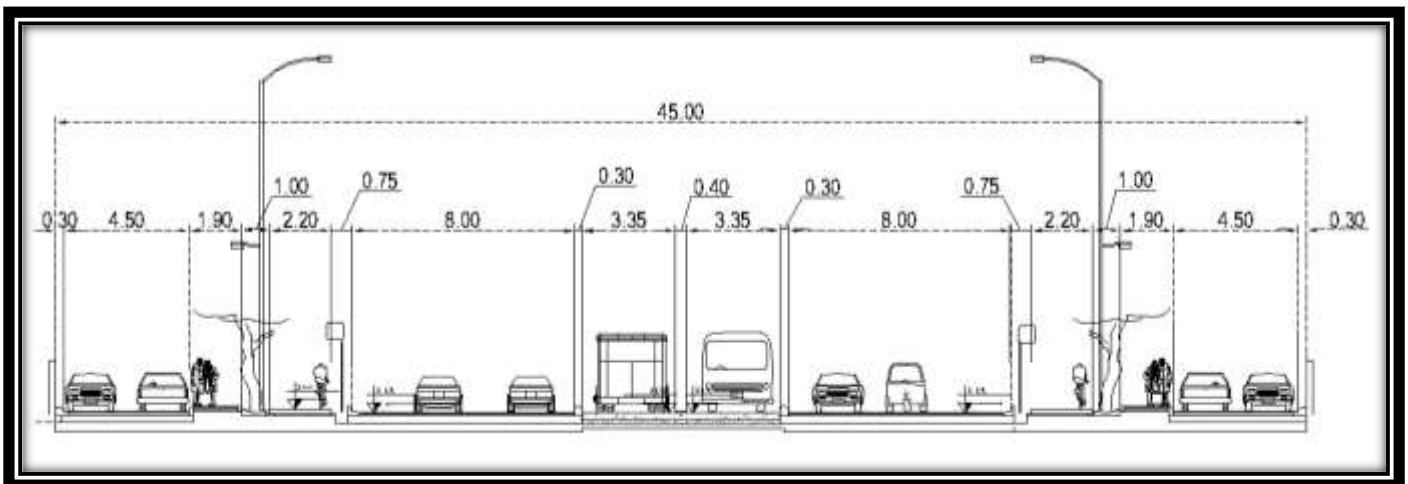

Figure 5-23 Cross Section –ROW 45m

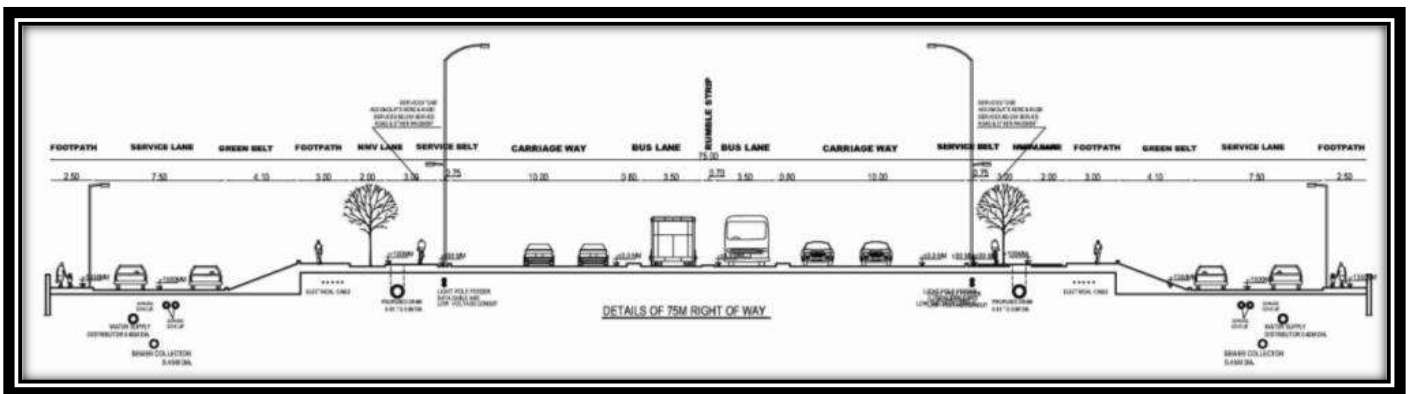

Figure 5-24 Cross Section –ROW 75m



## 5.14. READY RECKONERS

**Residential Zone**

Table 5-10 Ready Reckoner for Residential Zone

Type of Road	ROW( m)	Bus lane	lane (width)- One lane in each direction	Lane width- two lanes in each direction	Remaining Lane widths	Footpath (on each Side)	Green and Parking	Cycle Track / lane
Access: speed-15 km/hr	6	nil	3		0		Nil	mixed
	7	nil	3		1	0.5	Nil	mixed
	8	nil	3		2	1	Nil	mixed
	9	nil	3		3	1.5	Nil	mixed
	10	nil	3		4	1.5	1( on one side)	mixed
	11	nil	3		5	2	1( on one side)	mixed
	12	nil	3		6	2	2.5( on one side with intermediate parking bays )	mixed
	13	nil	3		7	2	3( on one side with intermediate parking bays )	mixed
Distributory: Speed -30 km/hr	14	nil	3		8	2.5	3( on one side with intermediate parking bays )	mixed
	15	nil	3		9	2	2.5( on both side with intermediate parking bays )	mixed
	16	nil	3		10	2.5	2.5( on both side with intermediate parking bays )	mixed
	17	nil	3		11	2.5	3( on both side with intermediate parking bays )	mixed
	18	nil	3		12	2	2.5( on both side with intermediate parking bays )	1.5 m painted
	19	nil	3		13	2.5	2.5( on both side with intermediate parking bays )	1.5 m painted
	20	nil	3		14	2	2.5( on both side with intermediate parking bays )	2.5 m segregated
	21	nil	3		15	2.5	2.5( on both side with intermediate parking bays )	2.5 m segregated
	22	nil	3		16	2.5	3( on both side with intermediate parking bays )	2.5 m segregated
	23	nil	3		17	2.5	3( on both side with intermediate parking bays )	3 m segregated
	24	paint ed	3	3	12	2	2( on both side with intermediate parking bays )	2 m segregated
	25	paint ed	3.1	3.1	12.6	2	2( on both side with intermediate parking bays )	2.3 m segregated
	26	paint ed	3.1	3.1	13.6	2	2.5( on both side with intermediate parking bays )	2.3 m segregated
	27	paint ed	3.1	3.1	14.6	2.5	2.5( on both side with intermediate parking bays )	2.3 m segregated
28	paint ed	3.1	3.1	15.6	2.3	2.5( on both side with intermediate parking bays )	3 m segregated	

29	paint ed	3.1	3.1	16.6	3	2.3( on both side with intermediate parking bays )	3 m segregated
30	paint ed	3.1	3.1	17.6	3	2.3( on both side with intermediate parking bays )	3.5 m segregated

**Commercial Zone**

Table 5-11 Ready Reckoner for Commercial Zone up to 30m ROW

ROW(m)	Bus lane	Carriage Way(width)	Footpath	Cycle Track / lane	Service road	Parking	Green
6	nil	nil	as per design	as per design	nil		
7	nil	nil	as per design	as per design	nil		
8	nil	nil	as per design	as per design	nil		
9	nil	nil	as per design	as per design	nil		
10	nil	nil	as per design	as per design	nil		
11	nil	2.75m	1.80m min	mixed	nil		
12	nil	2.75m	1.80m min	1.2 m painted	nil		
13	nil	2.75m	1.80m min	1.2 m painted	nil		
14	nil	2.75m	1.80m min	1.2 m painted	nil		
15	painted	3.1 m	1.80m min	1.5 m painted	nil		
16	painted	3.1 m	1.80m min	1.5 m painted	nil		
17	painted	3.1 m	1.80m min	1.5 m painted	nil		
18	painted	3.1 m	1.80m min	1.5 m painted	nil		
19	painted	3.1 m	1.80m min	1.5 m painted	nil		
20	painted	3.1 m	1.80m min	1.5 m painted	nil		
21	painted	3.1 m	2.0m min	1.5 m painted	nil		
22	painted	3.1 m	2.0m min	1.5 m painted	nil		
23	painted	3.1 m	2.0m min	1.5 m painted	nil		
24	painted	3.1 m	2.0m min	1.5 m painted	nil		
25	painted	3.1 m	2.0m min	2.2 m segregated	nil		
26	painted	3.1 m	2.0m min	2.2 m segregated	nil		
27	painted	3.1 m	2.0m min	2.2 m segregated	nil		
28	painted	3.1 m	2.0m min	2.2 m segregated	nil		
29	painted	3.1 m	2.0m min	2.2 m segregated	nil		
30	painted	3.1 m	2.0m min	2.2 m segregated	nil		

Table 5-12 Ready Reckoner for Commercial Zone above 30m ROW

Type of Road	ROW (m)	Bus lane	lane (width)- two lane in each direction	Lane width h- three lanes in each direction	Remaining Lane widths	Footpa th(on each Side)	Cy cle Tra ck	Serv ice Belt	Remai ning for MUZ	SERVICE LANE ( WITH PARKING )	Hawker Space as Priority
Sub Arterial: speed- 50 km/	31	3.3	3.1		12	2	2.5	0.75	1.5	Nil	
	32	3.3	3.1		13	2	2.5	0.75	2.5	Nil	
	33	3.3	3.1		14	2	2.5	0.75	3.5	Nil	
	34	3.3	3.1		15	2	2.5	0.75	4.5	Nil	

hr	35	3. 3	3.1		16	2	2.5	0.75	5.5	1( on one side)
	36	3. 3	3.1		17	2	2.5	0.75	6.5	1( on one side)
	37	3. 3	3.1		18	2	2.5	0.75	7.5	2.5( on one side with intermediate parking bays )
	38	3. 3	3.1		19	2	2.5	0.75	8.5	3( on one side with intermediate parking bays )
	39	3. 3	3.1		20	2	2.5	0.75	9.5	3( on one side with intermediate parking bays )
Arterial: Speed - 50 km/ hr	40	3. 3	3.1		21	2	2.5	0.75	10.5	2.5( on both side with intermediate parking bays )
	41	3. 3	3.1		22	2	2.5	0.75	11.5	2.5( on both side with intermediate parking bays )
	42	3. 3	3.1		23	2	2.5	0.75	12.5	3( on both side with intermediate parking bays )
	43	3. 3	3.1		24	2	2.5	0.75	13.5	2.5( on both side with intermediate parking bays )
	44	3. 3	3.1		25	2	2.5	0.75	14.5	2.5( on both side with intermediate parking bays )
	45	3. 3		3.3	18.6	2	2.5	0.75	8.1	2.5( on both side with intermediate parking bays )
	46	3. 3		3.3	19.6	2.5	3	1	6.6	2.5( on both side with intermediate parking bays )
	47	3. 3		3.3	20.6	2.5	3	1	7.6	3( on both side with intermediate parking bays )
	48	3. 3		3.3	21.6	2.5	3	1	8.6	3( on both side with intermediate parking bays )
	49	3. 3		3.3	22.6	2.5	3	1	9.6	2( on both side with intermediate parking bays )
	50	3. 3		3.3	23.6	2.5	3	1	10.6	2( on both side with intermediate parking bays )
	51	3. 3		3.3	24.6	2.5	3	1	11.6	2.5( on both side with intermediate parking bays )
	52	3. 3		3.3	25.6	2.5	3	1	12.6	2.5( on both side with intermediate parking bays )
	53	3. 3		3.3	26.6	2.5	3	1	13.6	2.5( on both side with intermediate parking bays )
	54	3. 3		3.3	27.6	2.5	3	1	14.6	2.3( on both side with intermediate parking bays )
	55	3. 3		3.3	28.6	2.5	3	1	15.6	2.3( on both side with intermediate parking bays )
	56	3. 3		3.3	29.6	2.5	3	1	16.6	
57	3. 3		3.3	30.6	2.5	3	1	17.6		
58	3. 3		3.3	31.6	2.5	3	1	18.6		
59	3. 3		3.3	32.6	2.5	3	1	19.6		
60	3. 3		3.3	33.6	2.5	3	1	20.6		
61	3. 3		3.3	34.6	2.5	3	1	21.6		

62	3. 3		3.3	35.6	2.5	3	1	22.6		
63	3. 3		3.3	36.6	2.5	3	1	23.6		
64	3. 3		3.3	37.6	2.5	3	1	24.6		
65	3. 3		3.3	38.6	2.5	3	1	25.6		
66	3. 3		3.3	39.6	2.5	3	1	26.6		
67	3. 3		3.3	40.6	2.5	3	1	27.6		
68	3. 3		3.3	41.6	2.5	3	1	28.6		
69	3. 3		3.3	42.6	2.5	3	1	29.6		
70	3. 3		3.3	43.6	2.5	3	1	30.6		
71	3. 3		3.3	44.6	2.5	3	1	31.6		
72	3. 3		3.3	45.6	2.5	3	1	32.6		
73	3. 3		3.3	46.6	2.5	3	1	33.6		
74	3. 3		3.3	47.6	2.5	3	1	34.6		
75	3. 3		3.3	48.6	2.5	3	1	35.6		
76	3. 3		3.3	49.6	2.5	3	1	36.6		
77	3. 3		3.3	50.6	2.5	3	1	37.6		
78	3. 3		3.3	51.6	2.5	3	1	38.6		
79	3. 3		3.3	52.6	2.5	3	1	39.6		
80	3. 3		3.3	53.6	2.5	3	1	40.6		

## 6. GRADE SEPARATED FACILITIES

The ideal situation on urban roads, is one where the pedestrian does not have to change level and in planning new facilities<sup>19</sup>, this should be seriously considered. In case a level change needs to be accommodated the following options need to be followed:

### 6.1. PEDESTRIAN SUBWAY

A subway is usually provided in those places where there is a high volume of traffic and it is not considered efficient to use a signal to intermittently stop the traffic flow. In such a situation, a subway allows the pedestrians access to the bus shelters without causing any delay to the traffic. The only negative aspect of a subway is that the pedestrians are required to walk more to cross a certain distance, which can be inconvenient.

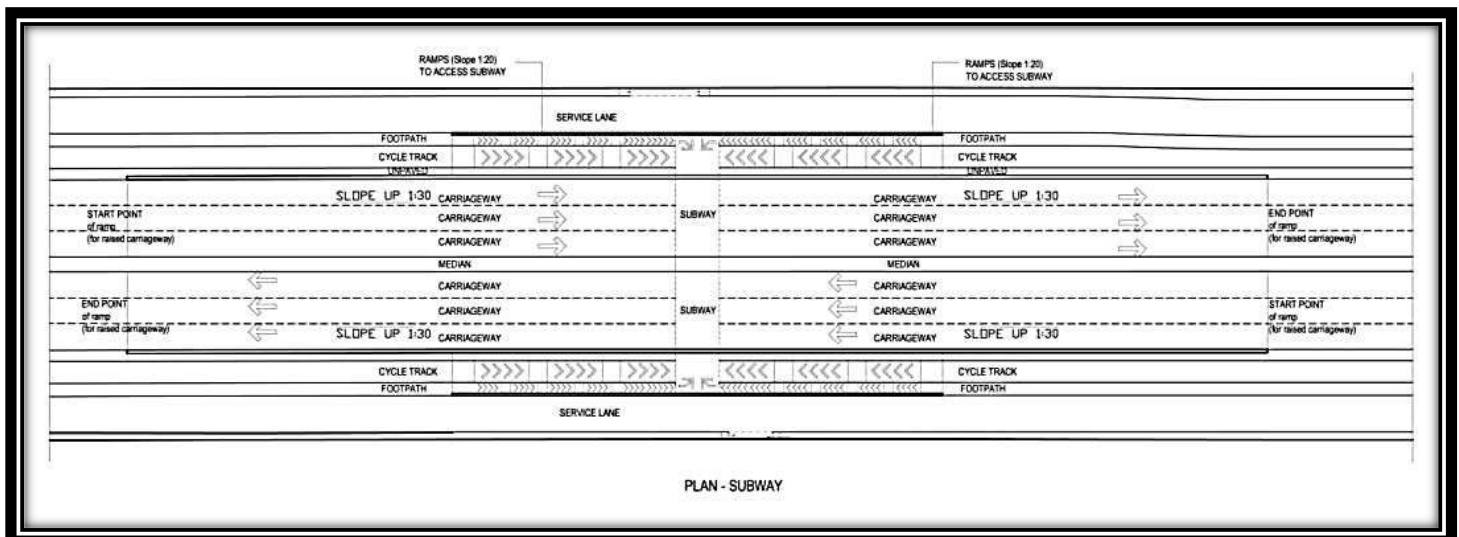

Figure 6-1 Introduction of subway - plan

#### Advantages

1. Pedestrians are able to cross the entire carriageway by using the subway

#### Disadvantages

1. Pedestrians have to take the subways to reach the bus shelters via ramp/steps instead of using pedestrian crossings, which are much more convenient.
2. A lot of space would be required to accommodate the ramp.

<sup>19</sup> Reducing Mobility Handicaps

3. it might affect the cost of construction.
4. In order to reach the bus shelter across the MV lane of distance 5.75m, the walking distance increases to 72m.

## 6.2. HALF SUBWAYS

In such subways, both the car lane users and the pedestrians (including cyclists, wherever segregated facility is provided) need to have a change in level. The car lanes are raised (+1.5m) using a ramp of 1:30 and the pedestrian paths (cycle tracks, wherever provided) are lowered using ramps of slope 1:20 with landing at appropriate intervals to equally achieve a clear height of 2.75m. (-1.5m). The advantage of such subways is that the walking length of a pedestrian is not increased to the extent that it discourages him from using it. Figure 6-2 shows a typical section of a half subway.

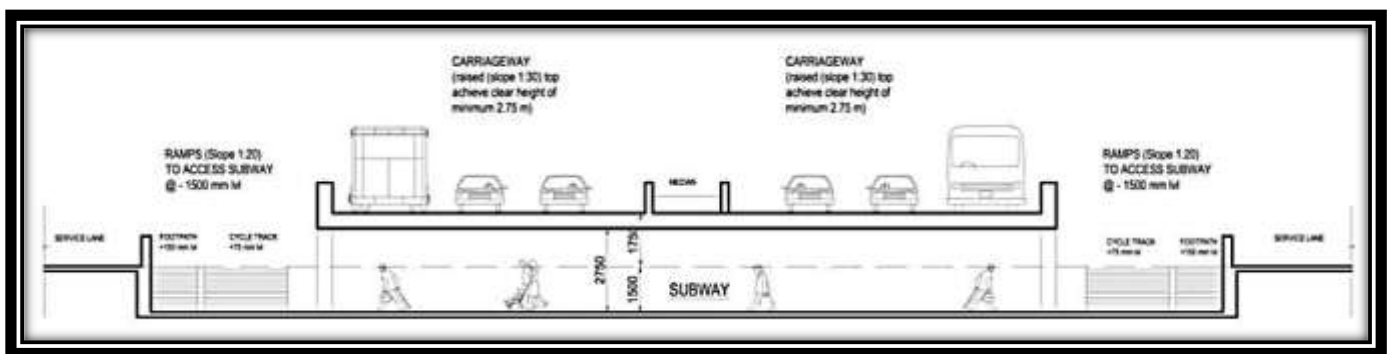

Figure 6-2 Half subway – section

## 6.3. FULL SUBWAYS

In this case, the pedestrian paths are lowered to a depth where a clear height of 2.75m minimum can be achieved using 1:20 slope ramps with appropriate landings. The car lanes encounter no level change and maintain the same level. Figure shows a typical section of a full subway.

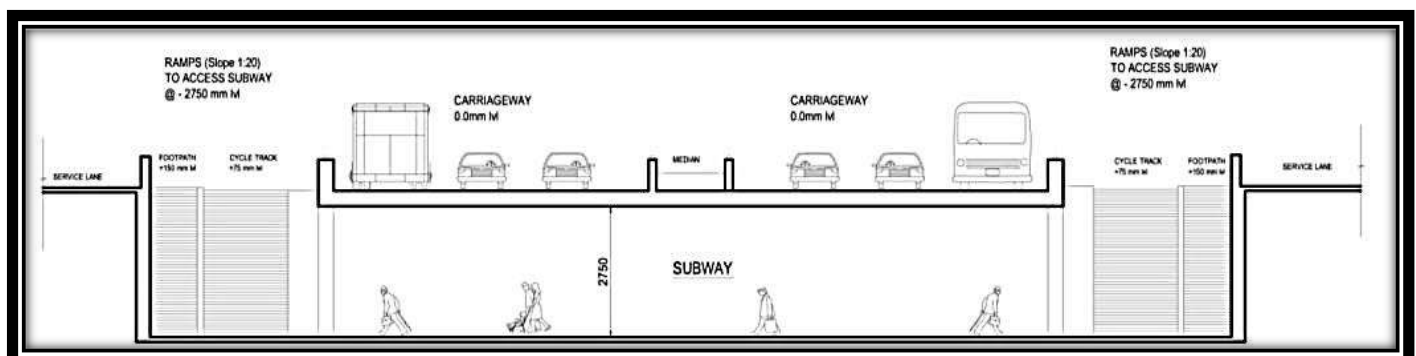

Figure 6-3 Full subway – section

#### 6.4. PEDESTRIAN OVER HEAD BRIDGES

Foot-over Bridges increase the walking length of a commuter for access, which is inconvenient. Such facilities need to be inclusive. To make it inclusive pedestrian facility, ramps (gradient 1:20 with landing at adequate intervals), lifts and steps (landings at appropriate levels) can be provided. Escalators are not inclusive measure. Introduction of such facilities would lead to a compromised arrangement of NMV and pedestrian track leading to sub optimal conditions if there is a restricted ROW.

This grade separated alternative is of least priority.

##### Advantages

1. Additional facility to the pedestrians.

##### Disadvantages

1. Not accessible by all, until all measures to access level difference is provided which includes lifts.
2. High cost of construction.
3. Requires more space at the sides to incorporate the facilities.
4. Increased walking length. In order to reach the bus shelter across the MV lane of distance of 2-3 lanes, the walking distance increases to 250m.

##### **Case 1: Access to the shelters via steps**

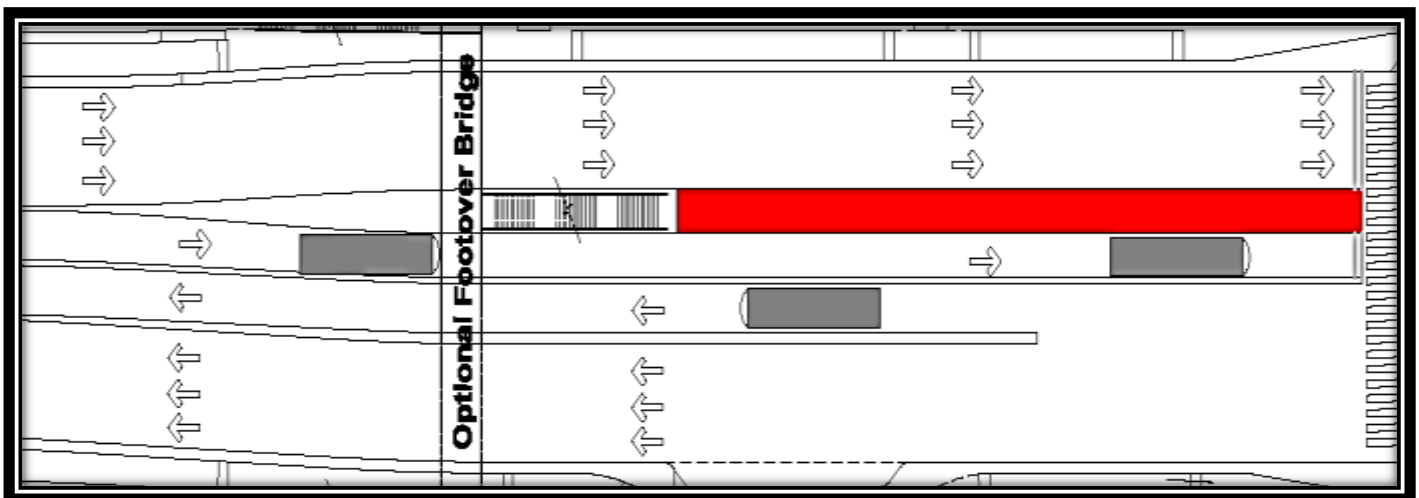

Figure 6-4 Access to the shelter – overhead pedestrian bridge with steps

Source: Bus Rapid Design Manual, TRIPP.



## Case 2: Access to the shelters via step

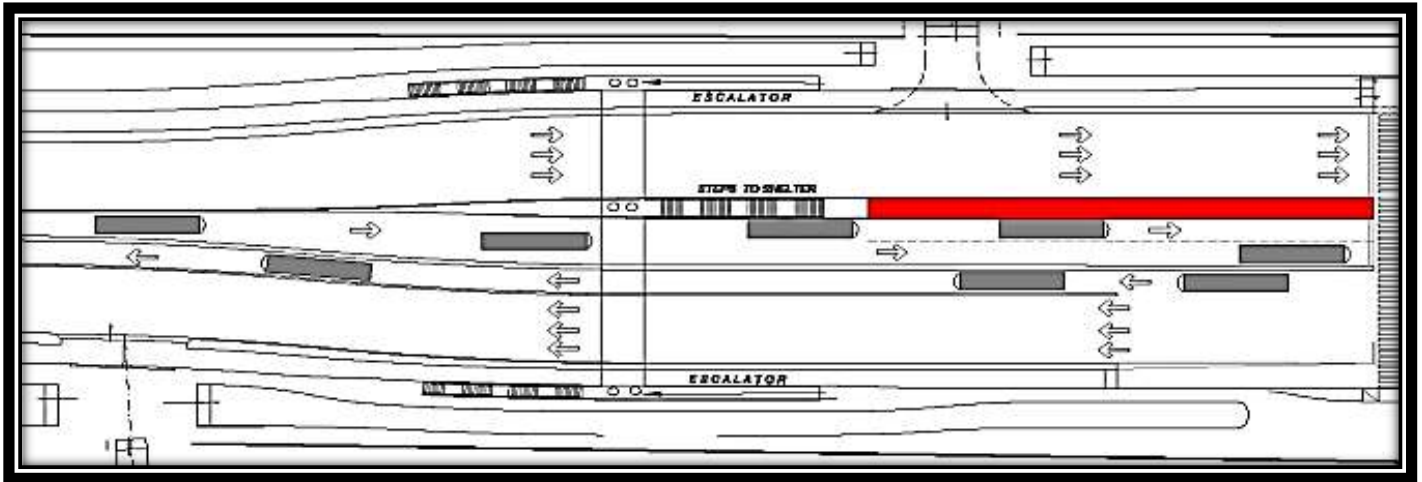

Figure 6-5 Access to the shelter – overhead pedestrian bridge with steps and escalator

Source: Bus Rapid Design Manual, TRIPP.

## Case 3: Access to the shelters via steps and escalators and lifts

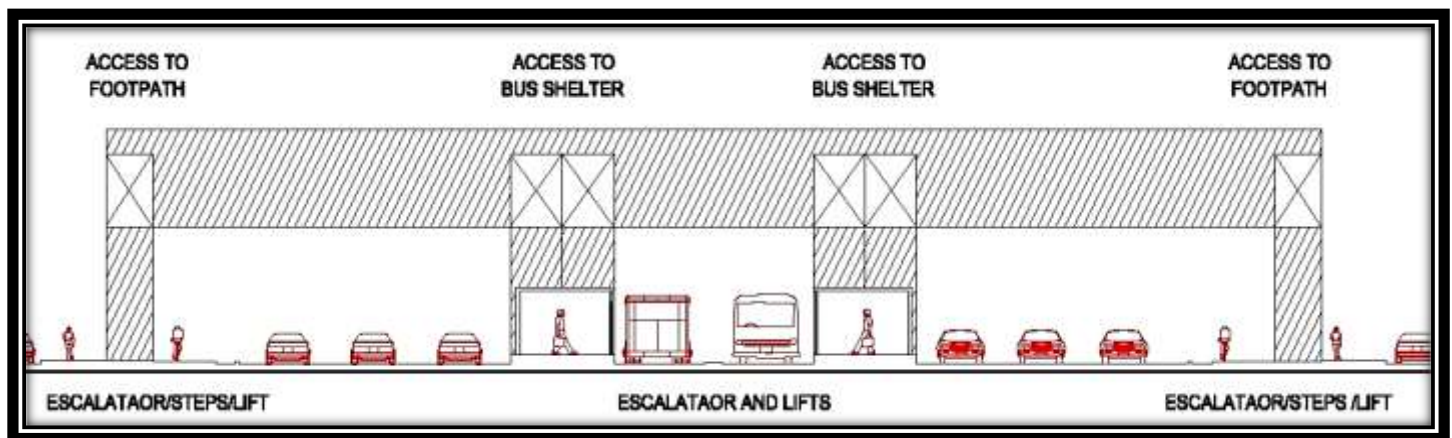

Figure 6-6 Access to the shelter – overhead bridge with steps and escalator and lifts

## 6.5. KEY FEATURES TO MAKE GRADE SEPARATED ALTERNATIVES INCLUSIVE:

- The approaches to footbridges and underpasses should comprise ramps / elevator , steps and handrails, except that in the underpass situation, the widths should be as generous as possible to provide an open aspect.
- A slope of **8% (1 in 12)** on footbridge ramps, where a slope of **5% (1 in 20)** with appropriate resting places, is preferable<sup>20</sup>.

<sup>20</sup> DTP Departmental Standard – BD 29/87 "Design Criteria for Footbridges"



- Within the underpass, a handrail set at **850mm-900mm** above the walking surface should be provided.
- To assist visually impaired people, warning tiles and, if possible, a colour contrast should be provided at the top and bottom of every flight of steps.
- The top and bottom steps should be brightly coloured and these areas should be well lit.
- Elevator/lift should be provided on both the entrances/exits and should have minimum internal dimensions of 1400mm x 1400mm.

### Grade Separated Junctions

At Junctions grade separation between different modes may be proposed to reduce complexity and increase safety. Here grade separated facility may be provided either for bicyclists and pedestrians, or one or more arms of vehicular traffic. In either case grade separated junction solutions are not very expensive and complex to execute, but introduce unpleasantness and obtrusiveness in the city space. Careful analysis of requirements and suggested alternatives should be undertaken before opting for such solutions.

### Grade Separated NMV Crossing

The three main criteria that need consideration in the design of Grade Separated NMV Crossings are location, type and geometric elements.

**Location** – At NMV junctions on arterial roads where high vehicular volume and speed results in higher risks for bicyclists and lesser priority to crossing bicycle traffic, a grade separated crossing facility may be preferred for cyclists and pedestrians to reduce their delays and increase safety. Grade separated crossings may be provided at major signalized intersections, roundabouts and other un-signalized locations where crossing of only bicyclists and pedestrians is to be allowed and at grade crossing is considered unsafe and inefficient. These are mid block locations where vehicle (right) turning is not permitted and the junction is signal free left turn only. Other reasons that may warrant the need for grade separation as against a NMV and pedestrian only signalized crossing are:

- To avoid interruption to vehicular traffic and reduce the risk of off peak hour accidents at a signalized crossing
- To discourage possible misuse of turning restrictions, by more flexible motorized modes such as two wheelers.

NMV path junctions with collector or access roads do not require grade separated provisions for crossing/turning cyclists as lower vehicular volumes and speeds are expected. Lower vehicular speeds and volumes at intersections allow junction designs where bicyclist requirements are balanced or prioritized over motor vehicles, while at mid blocks this results in gaps in the traffic stream allowing safer crossings for NMVs and pedestrians.

Wherever provided, grade separated crossings should be aligned to the natural crossing or turning path of the cyclists, leading to higher directness and shorter journey time.

**Type** – Grade separated crossings for NMVs can be either elevated (over pass/ bridge) or depressed (under pass/tunnel) from the road level. The advantages and disadvantages associated with each type of grade separated infrastructure have been listed in table 6-1.

Table 6-1 Advantages associated with grade NMV overpass or an underpass

NMV Over Pass	NMV Under Pass
Cyclists and pedestrians are more visible on an overpass, resulting in better social security than an underpass, which is more susceptible to street crime due to its hidden character.	Headroom requirements for cyclists are much less (about half) than that for the motorized vehicles (minimum required is 5.5m). This reduces the ramp length as well effort and time in undertaking a grade separated crossing.
Underpasses are generally claustrophobic, dingy while	Underpass based crossing can be further improved for cyclists

NMV Over Pass	NMV Under Pass
overpass can provide a sense of openness and a good view.	by raising the carriageway either partially or fully. Due to lesser headroom requirement, the cost of doing so is a fraction of the standard grade separated roads.
An overpass can be designed as an architecturally pleasing element, which contributes to the urban form.	In most cases bridges end up being ugly and obtrusive structures such as viaducts and long ramps, in the urban form. Here an underpass is more conducive as it can remain hidden and be less obtrusive due to its smaller access.
Overpasses are generally cheaper, quicker and easier to construct. Their site execution is achievable without effecting the movement of traffic on an existing road.	Crossing fast vehicular traffic on a narrow and long over pass, 7m above the ground can be quite a frightful experience for many. Here underpasses have an advantage.
	Underpasses offer better protection to the cyclists against elements of weather, especially strong gusts of wind, which may cause imbalance.
	In an underpass the descent is before the accent, hence the momentum built during the descent can be used to compensate the extra effort required in the accent.

Though both overpasses and underpasses have their distinct advantages, these need to be assessed from the point of site conditions and its surroundings. However purely from the point of view of NMV requirement of comfort, directness and coherence an underpass is a more appropriate option than an overpass. But whichever choice is made, the designer can (and should) minimize the disadvantages of the solution chosen. If e.g. the main road is depressed, a number of disadvantages of the over bridge for cyclists disappear. Similarly a rather open design of an underpass may diminish the insecure and claustrophobic experience of its users.

**Geometric Elements** – An underpass or an overpass for NMVs needs to be specifically designed for the NMV in all its elements to ensure, directness, safety and comfort of its users. The salient design features for each of these elements are:

**Access:** The access to the NMV underpass or an over pass should ensure that the directness and coherence of the user is not compromised. It should be directly aligned to the NMV path and should include minimum or no detours from the mainstream cycling route. Other important features that should be considered while designing the access of a NMV over or an underpass are:

- The designer should ensure that NMV users can visually connect and identify in time, an access to an underpass or an overpass on their approach to the infrastructure. The distance should be calculated on the basis of 2-3 seconds for reading, 2-3 seconds for understanding and 2-3 seconds to take corrective action in route and direction adjustments. Since NMVs easily ride at up to 20km/hr or about 6m/s, a grade separated infrastructure access (or the location where a bridge/tunnel access splits from main cycling route) for NMVs should be identifiable from a distance of 50m to 60m, along a bicycling route.
- A grade separated bicycling infrastructure along a mainstream cycling route should not be gated or controlled against NMV access at any point in time.
- Access control to prevent misuse by motorized vehicles especially two and three wheeled vehicles would need to be built into the design. Since the infrastructure needs to cater to the directness and comfort requirements of all NMVs, which include cycle rickshaws as well, cyclists carrying goods, physically constraining designs limiting the width at the access would neither be possible nor desirable to use. Other enforcement methods (refer section 8.2) such as the use of surveillance cameras and manning of the facility may be required to ensure effective control. Clear widths at the access of NMV grade separators should be as per minimum width requirements mentioned in chapter 2 of this guidebook.
- Access to NMV grade separated infrastructure should be effectively signposted and marked (refer section 6.9) to

ensure its visibility from the desired distance. This would help in increasing directness and comfort for the NMVs.

- NMV ramps should be designed as per minimum gradient requirements mentioned in chapter 2 of this guidebook.
- All surfaces should be designed for adequate control and to the minimum required levels of surface friction. Adequate care is required while selecting the material to avoid slippery conditions during normal and wet weather.
- NMV grade separator infrastructure including its access should be designed with due consideration to surface drainage in order to avoid puddles and slippery conditions.

**Clear Width:** The width of the bicycle tunnel (underpass) or a bridge (overpass) should be designed as per minimum prescribed dimensions after taking into account shy away distances from walls and railings. All tunnels and bridges should preferably be designed for and support two-way movement of NMVs. At most locations it may also be desirable to combine NMV and pedestrian crossing infrastructure into a single underpass or an overpass. Here additional width should be provided for the expected two-way volume of pedestrian traffic. The design should allow NMVs to use the middle of the bridge/tunnel while pedestrians use the edges. Here pedestrian paths should be defined distinctly from NMV paths using color, texture or level difference.

**Edges:** Edge design of the under pass or an over pass/bridge structure has important implications for the safety, comfort and attractiveness of NMVs. The following edge/railing design features should be considered:

- Bicycle railing on bridges and ramps should be designed to prevent cyclists from falling over. The railing height should therefore be higher than the 85<sup>th</sup> percentile of the height of the Center of Gravity of cyclists. For US standards this height is about 1166mm, which lifts it to about 1394mm on impact. Thus a desirable railing height to prevent overturning should not be less than 1.4m.
- Shy away distances from blank walls and other obstructions as per requirements mentioned in Chapter 2 (Basic Data) should be marked or paved accordingly. Locations where pedestrians also share the underpass, the shy away distance and additional width may be allocated to pedestrian facility as a 75mm raised (from the NMV path) path.
- Handrails may be required for pedestrians, especially disabled users. Two handrails, one at a height of 0.95m for walking pedestrians and the other at a height of 0.75m for wheelchair users should be provided in the tunnel and on the access ramps. The handrails should be 45 to 55mm in diameter and should be a minimum of 40mm away from the wall or the vertical supports (in case of 0.75m high railing if both are mounted on the same support).
- Railing should be provided on both sides of the grade separator and its ramps, and should be designed as per minimum IS load standards. AASHTO standards for railings specify a design load of 0.73kN/m laterally as well vertically on all horizontal members. It specifies that the desirable distance between posts or supports is to 1.5m, and it should be able to take a load of  $w*L$ , where  $w$  is equal to load on the design load on railings, i.e. 0.73kN/m and  $L$  is the distance between posts or vertical supports, applied at a height of 4.6m or the desired height of railings for NMVs.
- The spacing between the railing members or the gaps should be designed to prevent small objects from falling through. AASHTO prescribes the minimum clear spacing between vertical members up to a height of 0.69m to be 0.15m, and between 0.69 and 1.07m to be 0.2m

### ***Grade Separated Vehicular Junctions***

Grade separated vehicular crossings have often been used as a solution to solve local traffic problems at intersections within cities of all sizes, in the Indian Sub Continent. Completely signal free inner ring road in Delhi witnesses' peak hour travel speeds of as low as 6km/hr in some segments. This road is also the most notorious road in terms of annual road accident fatalities in the city. These examples and global research establishes that grade separated intersections should not be used within cities, where such car centric infrastructure discourages other modes and fuels the shift to private motor vehicles. This leads to a viscous cycle

where more demand for private vehicles leads to further congestion, leading to more grade separators. The by-product of this cycle is increased congestion, pollution and road accident fatalities throughout the city.

Experts are increasingly discarding these quick fix solutions across the world for more sustainable answers to counter congestion, pollution and road safety. These include retaining and increasing the share of trips by modes such as walking, cycling and public transport. Here road planning and infrastructure design is used to discourage private motorized vehicle use while promoting more sustainable modes within the city.

However grade separators may still be used to segregate fast moving highway or express way traffic moving across parts of the city. Such roads can be classified as dedicated flow function roads, with limited access. NMV movement along such roads is segregated from motorized traffic, and no at-grade intersection is expected. Such roads are grade separated at junctions, however NMV and city specific public transport infrastructure along with pedestrian paths remains at grade for all arms. The solution for the intersection at grade level may be based on the standard NMV specific arterial road junction design as discussed in previous sections.

## 7. BACKGROUND NOTES

### 7.1. ANNEXURE 1

#### Basic Information

This section focuses on the type of users, the basic dimensions and their technical specifications required while developing cross-sections and allocating space on road.

Pedestrian / Person on a wheelchair<sup>21</sup>

As discussed in the introduction, since the roads and its components need to be accessible by all, a person on a wheelchair is a key while designing pedestrian paths for two way movements and crossings.

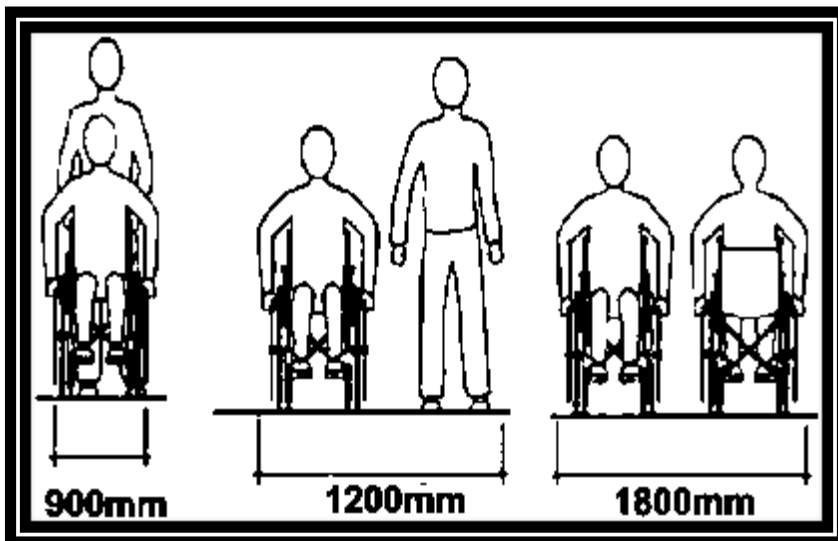

Figure 7-1 Person using wheelchair (elevation)

#### Non Motorised Vehicle

The term 'Non Motorized Vehicles' (NMVs) is apt for referring to different types of pedal powered vehicles used in the Indian sub-continent. These include different shapes and sizes of bicycles and multiple forms of tricycles. Tricycles are used to carry goods and passengers in almost all cities of the region. These are commonly referred to as cycle rickshaws. Apart from rickshaws, the use of bicycles to carry goods and passengers (pillion rider) is common in all cities of the sub-continent.

The bicycle is used as a retail platform to display and sell products, like toys, cooked food, tobacco products, etc. However, apart from the standard adult bicycle which conforms to Indian Standards, IS 10631, there are many modifications done to the bicycle to use it for transport and work by people from various sectors. Bicycles are commonly used to carry gas cylinders, milk cans, etc. It is also commonly used for vending.

<sup>21</sup> Pedestrian Guidelines ,UTTIPEC

The following table includes the categories of the specified and modified forms of bicycle.

Table 7-1 NMV Vehicle Dimensions

NMV	a Length (mm)	b Height (mm)	c Width with rider (mm)	d Handle bar width (mm)	E Wheel size (dia. in mm)
Adult Touring Bike	1800-1950	990-1200	750	500-600	560-710
Adult Touring Bike with goods (milk cans or gas cylinders)	1800-1950	990-1200	850-950	500-600	560-710
Passenger Rickshaw	2000-2200	990-1200	900-1000	500-600	560-710
Goods Rickshaw	2200-2400	990-1200	1000-1220	500-600	560-710
goods rickshaw	2400-2600	990-1200	1200-1400	500-600	560-710

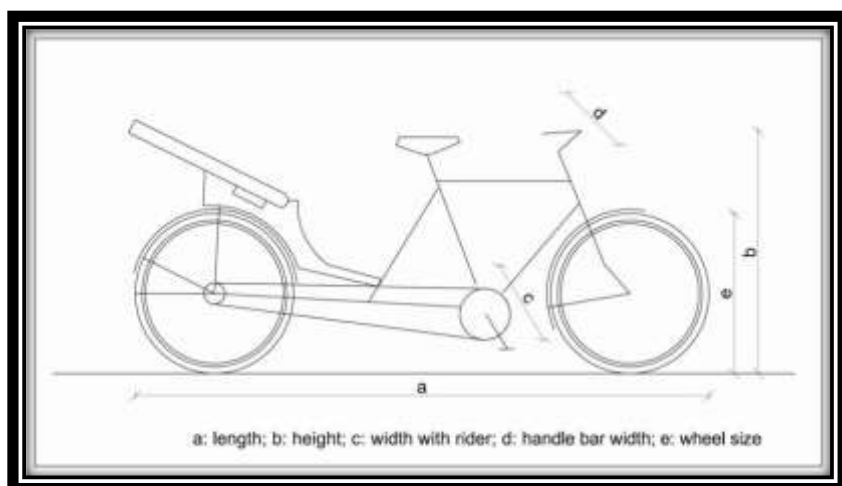

Figure 7-2 Vehicle dimensions for Passenger Rickshaw

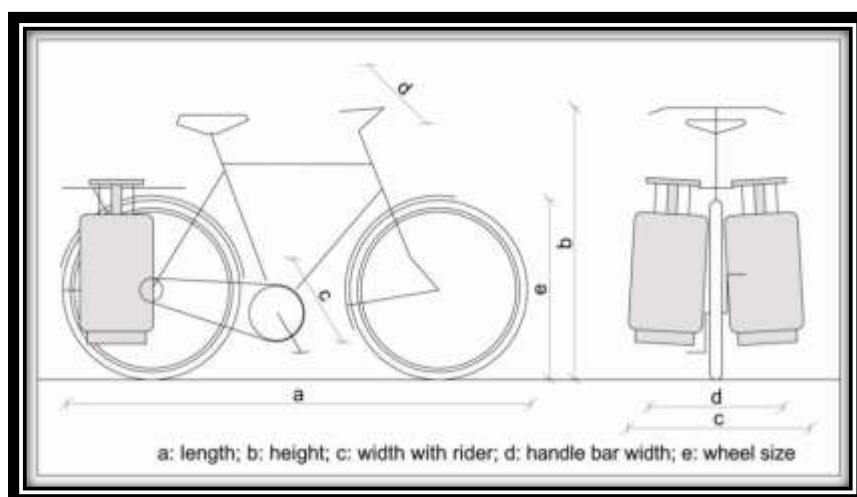

Figure 7-3 Vehicle dimension for adult touring bike with goods

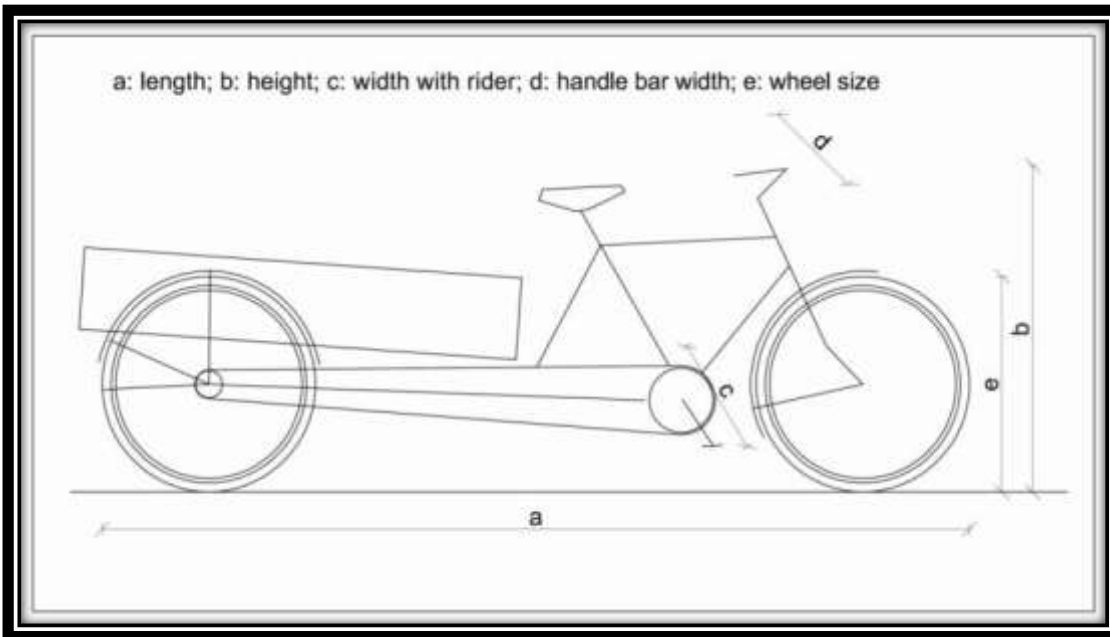

Figure 7-4 Vehicle dimensions for goods rickshaw

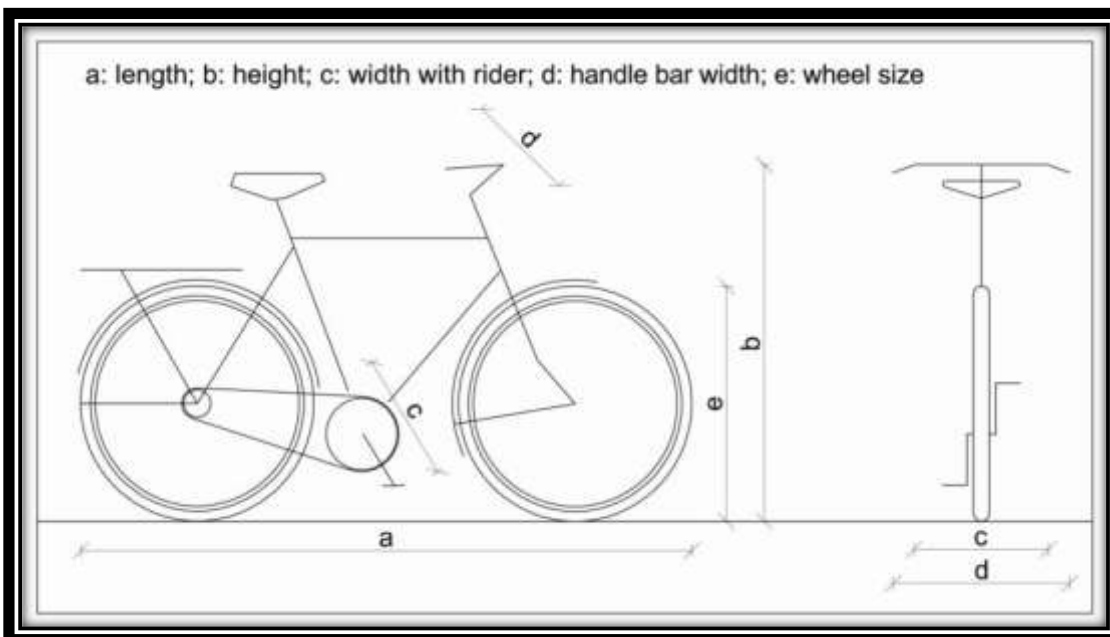

Figure 7-5 Vehicle dimensions of adult touring bike

Table 7-2 Characteristics –cycles

Types of vehicle Characteristics	Cycles		
	Mean	Min	Max
Length	2	1.25	2
Width	0.6	0.2	0.6
Max .desired speed	10	5	20
Max. acc.	1.5	0.5	1.5
Normal deceleration	<b>2.5</b>	<b>2.5</b>	<b>4</b>
Max. deceleration	6	6	6
Speed acceptance	1	1	1
Min distance veh	1	1	1
Give way time	5	5	5
Guidance acceptance	1	1	1

**Motorized Vehicles**Two wheelers

Table 7-3 Characteristics –2 wheelers

Types of vehicle Characteristics	2 wheeler		
	Mean	Min	Max
Length	2	2	2
Width	0.7	0.7	0.7
Max .desired speed	40	30	50
Max. acc.	1.5	1	2.5
Normal deceleration	2.5	2.5	5
Max. deceleration	5	5	5
Speed acceptance	1	1	1
Min distance veh	1	1	1
Give way time	30	30	30
Guidance acceptance	1	1	1



## Three wheeled Scooter Rickshaws (TSR) / Goods vehicles

These are the motorized rickshaw commonly used as a feeder transport in big cities and also an intermediate para transit(IPT) along with many modes of NMV for small sized cities.

Table 7-4 Characteristics –3 wheelers

Types of vehicle	3 wheeler		
Characteristics	Mean	Min	Max
Length	1.7	1.7	1.7
Width	1.5	1	2
Max .desired speed	30	20	40
Max. acc.	1.5	1.5	2
Normal deceleration	2.5	2	2.5
Max. deceleration	5	5	6
Speed acceptance	1	1	1
Min distance veh	1	1	1
Give way time	30	30	30
Guidance acceptance	1	1	1

Cars

Table 7-5 Characteristics –Cars

Types of vehicle	Cars		
Characteristics	Mean	Min	Max
Length	4	3	4.75
Width	2	1.4	2
Max .desired speed	45	40	50
Max. acc.	3	3	3
Normal deceleration	4	4	4
Max. deceleration	6	6	6
Speed acceptance	1	1	1
Min distance veh	1	1	1
Give way time	30	30	30
Guidance acceptance	1	1	1

Car<sup>22</sup>

Figure 7-6 Direction of path covered by a passenger car

<sup>22</sup>CROW, Record 15, Recommendations For Traffic Provisions in Built Up Areas, ASVV, Chapter 4.3, Traffic Engineering Premises, Figure 4.3/8, Page 125

Fire Tender<sup>23</sup>

Figure 7-7 Direction of path covered by a Fire Tender

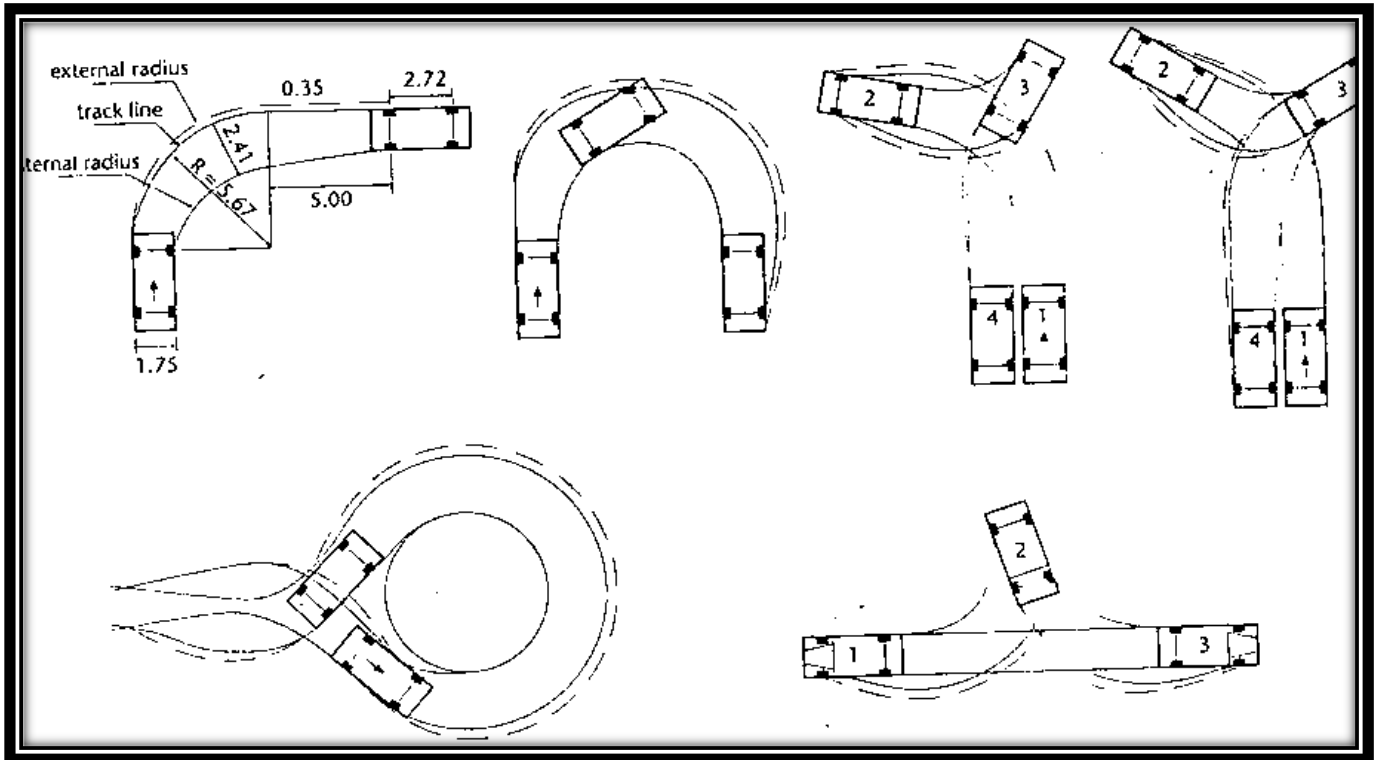
<sup>23</sup> CROW, Record 15, Recommendations For Traffic Provisions in Built Up Areas, ASVV, Chapter 4.3, Traffic Engineering Premises, Figure 4.3/11, Page 127

Goods vehicle<sup>24</sup>

Figure 7-8 Direction of path covered by Goods Vehicle

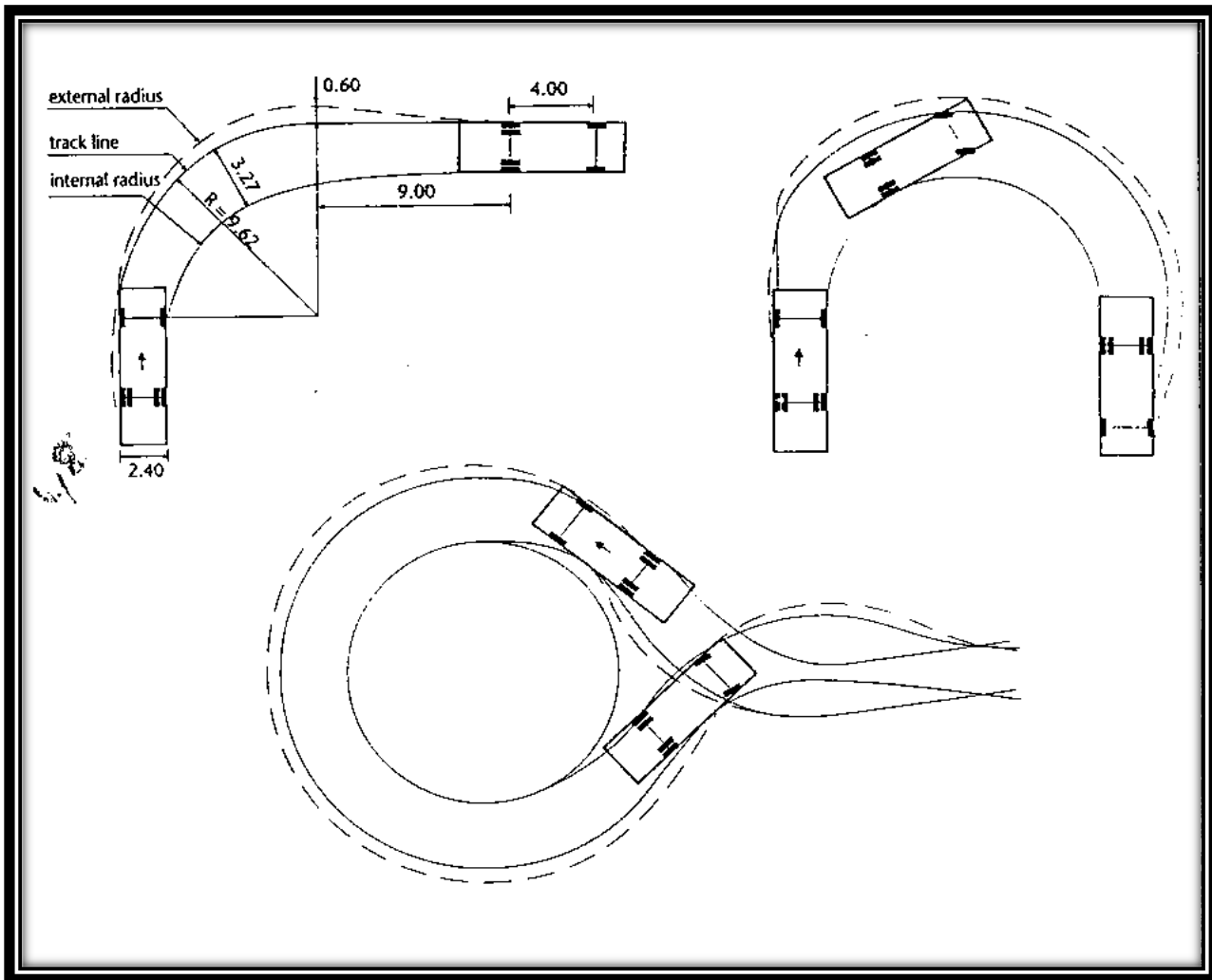
<sup>24</sup>CROW, Record 15, Recommendations For Traffic Provisions in Built Up Areas, ASVV, Chapter 4.3, Traffic Engineering Premises, Figure 4.3/9, Page 126

Table 7-6 Characteristics –Buses

Type of Vehicle	DTC Bus			Blue line Bus			Mini Bus		
Characteristics	Mean	Min	Max	Mean	Min	Max	Mean	Min	Max
Length	7.5	7.3	10	7.5	7.3	10	4	4	4
Width	2.2	2.2	2.5	2.2	2.2	2.5	2	2	2
Max .desired speed	45	30	70	40	30	70	40	30	70
Max. acc.	3	3	3	3	3	3	3	3	3
Normal deceleration	6	2	6	6	2	6	4	4	4
Max. deceleration	6	6	6	6	6	6	6	6	6
Speed acceptance	1	1	1	1	1	1	1	1	1
Min distance veh	1	1	1	1	1	1	1	1	1
Give way time	90	30	90	90	30	90	30	30	30
Guidance acceptance	1	1	1	1	1	1	1	1	1

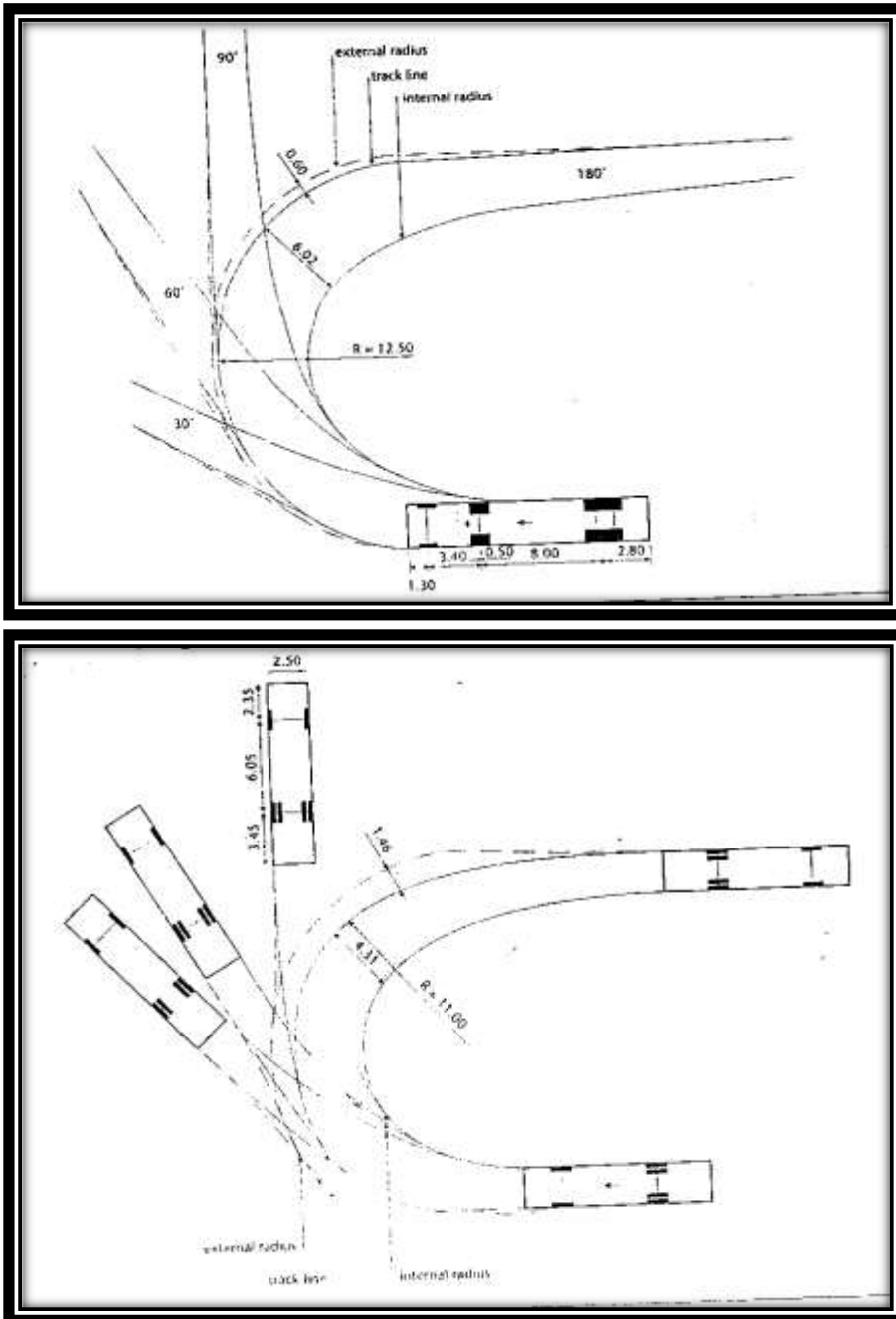
Table 7-7 Characteristics –High Capacity Bus

Types of vehicle	HCB		
Characteristics	Mean	Min	Max
Length	10.5	10.5	10.8
Width	2.5	2.4	2.5
Max .desired speed	60	40	80
Max. acc.	3	3	3
Normal deceleration	6	4	6
Max. deceleration	6	6	6
Speed acceptance	1	1	1
Min distance veh	1	1	1
Give way time	30	30	30
Guidance acceptance	1	1	1

## 7.2. ANNEXURE 2

### Data Collection

Before planning, data collection is an important tool for the designers and engineers to proceed further to the cross section design and detailing. The data, geometric survey, activity survey and traffic survey will provide a coherent data base to be translated in road plans.

#### Geometric Survey

Usually taken up by *Total station method*, the survey shall include picking up all details along the road, necessary for planning dedicated lanes for buses and separate lanes for other fast and slow moving traffic. The accuracy of the survey is of importance. It includes the following:

#### Road Right of Way

Width of carriageway, footpaths, central verge, drains. where there is a sudden change in width of road, physical measurement shall be marked on the drawings;

Road / lane name and location of all the approach roads;

Level crossings (if any) with their numbers, class, manned or unmanned, Road-Over-Bridges (ROBs) Road-Under-Bridges (RUBs) and Foot-Over Bridges (FOBs), Railway bridges with their structural details, angle of crossing and road & rail levels; and

Storm water drains, open drains, nallahs, with bed levels, HFL and manhole details.

Details of existing flyovers including details of at-grade service roads at such locations.

#### Buildings and Structures

Dimensions and Details of built-up areas including setbacks from building line/boundary wall, with plot numbers and Ownership such as private or government and usage i.e. residential or commercial etc. within survey limits;

Type of building, such as temporary, permanent including number of storeys and basement details;

Details of religious structures such as temple, Gurudwara, Mosque, Church, Monuments, tombs, etc;

Details of land along the route and their uses such as residential, commercial, religious, parks, green areas, vacant lands etc;

Name of all the adjacent colonies including number of houses, Jhuggie Clusters with number of jhuggies along the route; and squatters (no legal authority on Land-ADB)

Encroachments of the right of way.

#### Utilities

Utility services such as electric lines, telephone lines, H.T., L.T. Transmission lines;

Vertical Clearances to power line or telephone / telegraph lines at road crossings and at locations where Flyovers are proposed

Traffic Signals, light posts, bus stops, Junction boxes (telephone and power), wire and water hydrants (fire fighting and others), transformers, telephone posts;

Any other structure or details which may be relevant,

Underground utilities (Public & Private) i.e. cables, sewers, pipelines.

### **Trees**

Location of trees with girth more than 30 cm (measured at 1/2 m height from ground level)

Detail of location, type, their species, girth diameter and reference number duly shown on the plan shall be made. The trees at site to be numbered and marked with paint including the identification of trees, which can be saved (without cutting), if falling in median.

### **Activity Survey**

The activity survey helps us understand the user behavior according to local factors and gives the designer a better understanding to translate the future plans based on such observations which cannot be taken by a total station survey. This would include informal activities along the corridor marked on the total station survey plan. All activities shall be marked as per appropriate symbol and size indicating the quantity and spread accurately. These shall include the following:

Formal and Informal Parking as per type, location and character

Shop spillovers on the existing corridor in terms of goods displayed and/or stored on public land

Hawker activity as per type of hawkers (mobile, stationary or semi permanent) indicating area occupied, numbers, spread, etc.

Any other observed informal activity on site, which is not recorded in the total station survey.

The site observation needs to be well documented and superimposed on the geometric survey plan. Figure 11 and Figure 12 indicate that all activities including hawkers, bus stops, parking etc have been first marked as dots on site and then translated into a CAD drawing over the geometric plan.

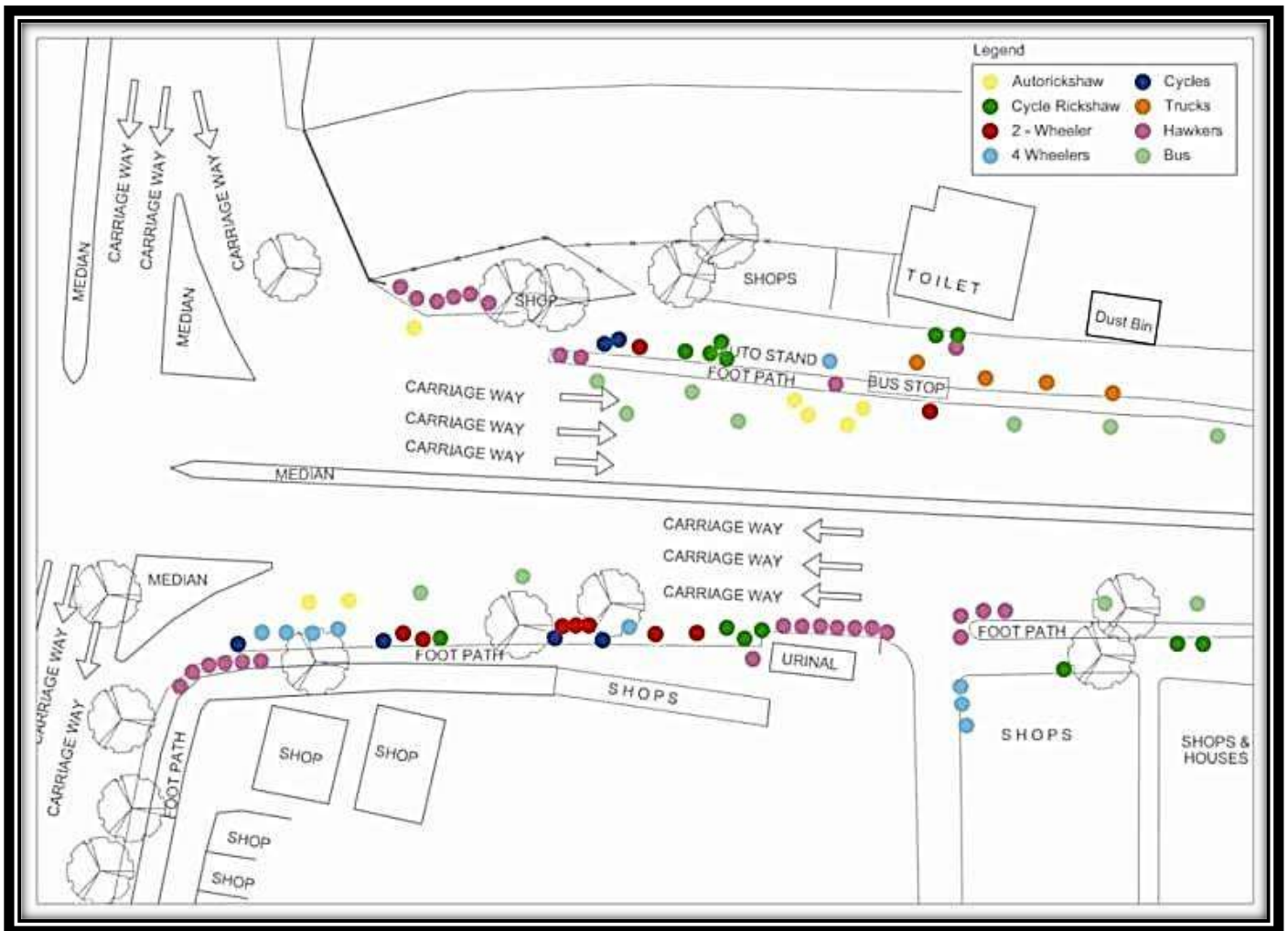

Figure 7-9 Identification of activities on a survey plan at site



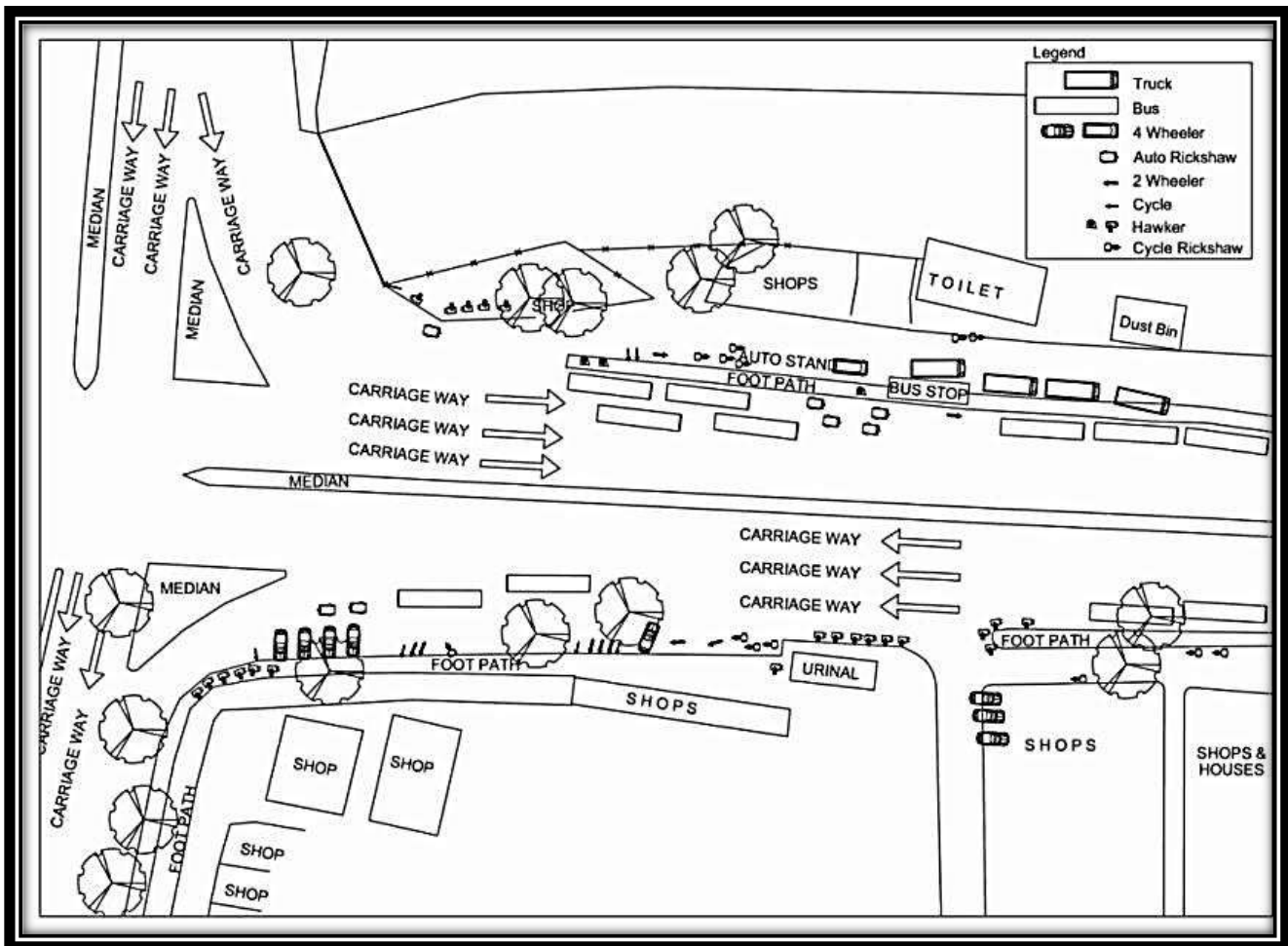

Figure 7-10 Land use plan - Transfer to drawing

### Traffic Surveys

The work involves getting the actual numbers. In order to get a comprehensive picture, the following data need to be .

Classified traffic volume counts including two wheelers

Intersection Mode wise Turning Movement counts

Parking Surveys

On board and boarding & alighting surveys for public transport commuters

OD Survey

Speed and delay survey

Pedestrian counts

Accident Data: Accident data can help in redesigning areas or adding measures like traffic calming. It is a good data to help improve the design and detailing proposed.

Pedestrian Survey - Understanding the pedestrian behaviour at the micro-level is necessary to design pedestrian paths (including hawkers and vendors) and pedestrian crossings.

### 7.3. ANNEXURE 3

#### Sight Distance

Sight distance is the length of roadway a driver can see from his vehicle at a certain speed. For the purpose of measuring the stopping sight distance or visibility ahead IRC has suggested the height of eye level of driver as 1.2 m and the height of the object as 0.15m above the road surface.

According to IRC three sight distance situations are considered in the design

Stopping or absolute minimum sight distance

Passing Sight Distance or Overtaking Sight Distance

Intersection sight distance

**Stopping or absolute minimum sight distance:** The available sight distance on a roadway should be sufficiently long to enable a vehicle traveling at or near the design speed to stop before reaching a stationary object in its path

Stopping sight distance is the sum of two distances: (1) the distance traversed by the vehicle from the instant the driver sights an object necessitating a stop to the instant the brakes are applied (total reaction time); and (2) the distance needed to stop the vehicle from the instant the brake application begins. These are referred to as lag distance and braking distance, respectively.

**Lag distance:** during the total reaction time the vehicle may be assumed to proceed forward with a uniform speed at which the vehicle has been moving and this speed may be taken as the design speed. If 'v' is the design speed in m/sec and 't' is the total reaction time of the driver in seconds. Then the lag distance will be 'v.t' meters.

The IRC has also recommended the value of reaction time  $t=2.5$ sec for the calculation of stopping distance.

**Braking distance:** The approximate braking distance of a vehicle on a level roadway traveling at the design speed of the roadway may be determined from the following equation.

$$l = v^2 / (2gf)$$

l = braking distance, m

g= acceleration due to gravity = 9.8 m/sec<sup>2</sup>

f= design coefficient of friction (a/g)

a= deceleration rate

***Intersection sight distance:***

Apart from this three sight distance the following sight distances are considered by the IRC in highway design.

***Intermediate sight distance:***

This is defined as twice the stopping sight distance. When overtaking sight distance cannot be provided, intermediate sight distance is provided to give limited overtaking opportunities to fast vehicles.

E.g.; on horizontal curves the overtaking sight distance requirements cannot always be fulfilled especially on sharp curves, in such cases ISD may be provided.

***Head light sight distance:***

This is the distance visible to a driver during night driving under the illumination of the vehicle head light. The sight distance is critical at up gradients and at the ascending stretch of the valley curves. Head light sight distance is equal to stopping sight distance given in table 5-2.

**Design Speed**

Super elevation:

A horizontal curve is a curve in plan to provide change I direction to the center line of road. When a vehicle traverses a horizontal curve, the centrifugal force acts horizontally out wars through the center of gravity of the vehicle.

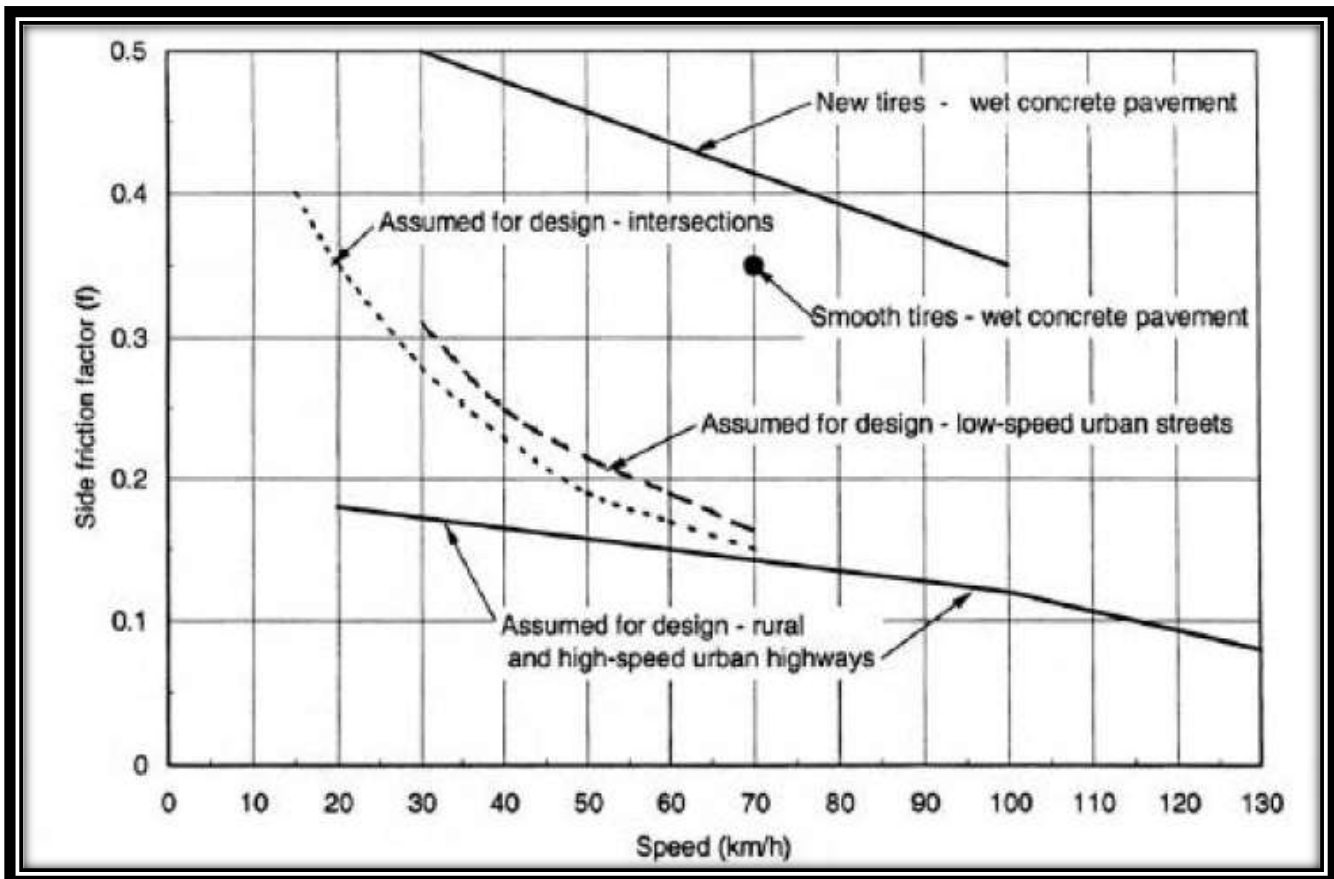

Figure 7-11 Speed and Side friction factor graph

**Summit curves:** the problem in designing the summit curve is to provide adequate sight distances. The SSD should be provided at all sections of the road system. As far as possible safe OSD, ISD should also be available on these curves for important highways.

A simple parabolic curve is used as the summit curve due to the following reasons.

A parabola is very easy for arithmetical manipulations for computing ordinates

Use of a simple parabola as summit curve is found to give good riding comfort.

#### Length of summit curve:

While designing the length of the parabolic summit curves, it is necessary to consider the SSD, and OSD separately. As mentioned earlier, it is essential to provide sight distance at least equal to the SSD at all points on the road so as to avoid accidents due to inadequate sight distance.

Length of summit curve for SSD:

Case (i): When length of the curve is greater than the sight distance ( $L > SSD$ )

$$L = NS^2 / (\sqrt{2H} + \sqrt{2h})^2$$

L = length of summit curve, m

S = stopping sight distance. M

N = deviation angle, equal to algebraic difference in grades, radians or tangent of the deviation angle.

H = height of eye level of driver above roadway surface, m = 1.2 m (according to IRC)

h = height of subject above the pavement surface, m = 0.15m (according to IRC)

i.e.  $L = NS^2 / 4.4$

Case (ii): When length of the curve is less than the sight distance ( $L < SSD$ )

$$L = 2S - (\sqrt{2H} + \sqrt{2h})^2 / N$$

By substituting the values of  $H=1.2$  and  $h = 0.15m$

$$L = 2S - 4.4 / N$$

Length of summit curve for OSD:

Case (iii): When length of the curve is greater than the overtaking sight distance ( $L > OSD$ ).

$$L = NS^2 / (\sqrt{2H} + \sqrt{2h})^2$$

In this case  $H = h = 1.2$

i.e  $L = NS^2 / 9.6$

where S = OSD or ISD

Case (iv): When length of the curve is less than the overtaking sight distance ( $L < OSD$ )

$$L = 2S - (\sqrt{2H} + \sqrt{2h})^2 / N$$

In this case  $H = h = 1.2$

$$L = 2S - 9.6 / N$$

**Valley curves:**

The length of the valley curves should be such that for night travel, the headlight beam distance is equal to the SD. The length of the curve may be calculated as under

Case (i): When length of the curve is greater than the required sight distance ( $L > S$ )

$$L = NS^2 / (1.5 + 0.035S)$$

Where S = SSD, m

Case (ii): When length of the curve is less than the required sight distance ( $L < S$ )

$$L = 2S - (1.5 + 0.035S) / N$$